

From: [redacted] - LTC G3  
Sent: Tuesday, August 03, 2004 3:10 PM  
To: [redacted] LTC G3  
Cc: [redacted] COL  
Subject: RE: Detainee Ops



Training Guidance  
for Units pe...

All soldiers are required this training related to detainee operations

- 2.O. INTRODUCTION TO DETAINEE OPERATIONS IAW USAMPS DETAINEE OPERATIONS TRAINING SUPPORT PACKAGE.
- 2.P. ALL REGULATORY BRIEFINGS SPECIFIED IN APPLICABLE ARMY PUBLICATIONS:  
LAW OF WAR (GENEVA CONVENTION), IAW FM 27-10 THE LAW OF LAND WARFARE  
ARMY VALUES
- 2.Q. COMPLY WITH THE LAW OF WAR AND THE GENEVA AND HAGUE CONVENTIONS (181-105-1001)

All leaders are required this training related to detainee operations 3.Q. ENFORCE THE LAW OF WAR AND THE GENEVA AND HAGUE CONVENTIONS (181-105-2001) 3.R. SUPERVISE THE HANDLING OF ENEMY PERSONNEL AND EQUIPMENT AT THE SQUAD LEVEL (191-379-4450)

Have attached the detainee ops guidance ... but we need to package a change because this list doesn't match the TSP that USAMPS developed (action working this week).

LTC [redacted]  
G3 Training  
DSN 367-[redacted] Comm 404-[redacted]

-----Original Message-----  
From: [redacted] - LTC G3  
Sent: Tuesday, August 03, 2004 7:56 AM  
To: [redacted] LTC G3  
Subject: FW: Detainee Ops

[redacted] would you send me the electrons to the final detainee ops training guidance. [redacted]

-----Original Message-----  
From: [redacted] COL  
Sent: Tuesday, August 03, 2004 5:41 AM  
To: [redacted] LTC G3; [redacted] LTC - G3  
Subject: FW: Detainee Ops

[redacted] Please show me what we put out on this subject first thing this morning. Thanks.

-----Original Message-----  
From: [redacted] COL [mailto:[redacted]@fifth.army.mil]  
Sent: Monday, August 02, 2004 7:12 PM  
To: [redacted] COL  
Cc: Burns, Julian H. MG - DCS G-3/5/7; [redacted] LTC; [redacted] LTC;  
Subject: Detainee Ops

[redacted] wanted to run this past you before we launch our guidance, that ALL deploying OIF/OEF soldiers will receive the 8 hour Introduction to Detainee Ops training we received from you. Only units that have the specific detainee mission are required all the other related tasks which amounted to about five days of training.

thanks

COL [REDACTED]  
DCS, G3  
Fifth United States Army  
DSN: 471- [REDACTED]  
CML: 210- [REDACTED]  
[REDACTED]

"We will either find a way or make one!"  
Hannibal  
Nov, 218 BC

BT  
UNCLAS

SUBJ/TRAINING GUIDANCE FOR UNITS PERFORMING INTERNMENT/DETAINMENT  
OPERATIONS ISO OPERATION IRAQI FREEDOM//

RMKS/

1. PURPOSE. THIS MESSAGE PROVIDES TRAINING GUIDANCE FOR ALL UNITS PERFORMING INTERNMENT AND DETAINMENT OPERATIONS IN SUPPORT OF OPERATION IRAQI FREEDOM.

2. THEATER SPECIFIC INDIVIDUAL TRAINING. SEE FORSCOM OIF TRAINING GUIDANCE CHANGE 3.

3. THEATER SPECIFIC LEADER TRAINING. SEE FORSCOM OIF TRAINING GUIDANCE CHANGE 3.

4. GENERAL COLLECTIVE COMPETENCIES. UNITS SHOULD BE TRAINED TO A "P" IN COMPETENCIES THAT ARE GENERAL IN NATURE AND INHERENT IN A UNITS NORMAL DUTIES AND RESPONSIBILITIES. THESE INCLUDE:

4.A. THEATER SPECIFIC INTERNMENT AND DETAINEE OPERATIONS COLLECTIVE TASKS.

- 4.A.1. INTRODUCTION TO DETAINEE OPERATIONS (OIF DETAINEE DEFINITIONS)
- 4.A.2. COMMUNICATE WITH DETAINEES (MUSLIM CULTURAL AWARENESS)
- 4.A.3. GENEVA CONVENTIONS (HUMANE TREATMENT OF DETAINEES)
- 4.A.4. STRESS MANAGEMENT
- 4.A.5. HIV/UNIVERSAL PRECAUTIONS WITHIN DETAINEE OPERATIONS
- 4.A.6. USE OF FORCE FOR DETAINEE AND INTERROGATION OPERATIONS DROE/TROE)
- 4.A.7. DETAINEE FRISK, UNDRESS, CELL AND AREA SEARCH PROCEDURES
- 4.A.8. RESTRAINT PROCEDURES FOR DETAINEES
- 4.A.9. PERSONAL SAFETY AWARENESS
- 4.A.10. REACT TO A PHYSICAL ATTACK USING UNARMED SELF DEFENSE TECHNIQUES
- 4.A.11. FORCED CELL MOVE (FCM) PROCEDURES
- 4.A.12. RESPOND TO A BOMB THREAT AND/OR A BOMB WITHIN DETAINEE OPERATIONS
- 4.A.13. EMERGENCY ACTIONS FOR FIRE, ESCAPES AND DISORDERS WITHIN DETAINEE FACILITIES
- 4.A.14. CELL BLOCK OPERATIONS WITHIN A DETAINEE CAMP
- 4.A.15. ACCOUNTABILITY PROCEDURES
- 4.A.16. PERFORM SECURITY AND CONTROL ACTIVITIES WITHIN DETAINEE OPERATIONS
- 4.A.17. SPECIAL HOUSING UNIT (SHU) / SEGREGATION OPERATIONS
- 4.A.18. MAIN GATE/SALLY PORT OPERATIONS
- 4.A.19. VISITATION PROCEDURES
- 4.A.20. BIOMETRIC AUTOMATED TOOLSET SYSTEM (BATS) AND NATIONAL DETAINEE REPORTING SYSTEM (NDRS)
- 4.A.21. CAPABILITIES AND LIMITATIONS OF THE INTERROGATION
- 4.A.22. SUPPORT RELATIONSHIPS BETWEEN MILITARY POLICE AND MILITARY INTELLIGENCE IN DETAINEE OPERATIONS
- 4.A.23. HUMANE TREATMENT OF DETAINEES
- 4.A.24. INTERNATIONAL AGREEMENTS AND REGULATIONS RELATING TO DETAINEES
- 4.A.25. INTEGRATION OF PROCEDURES FOR EVACUATION, CONTROL, AND ADMINISTRATION OF DETAINEES

000983

4.A.26. ESCORT PROCEDURES WITHIN DETAINEE OPERATIONS  
4.A.27. NON-LETHAL WEAPONS CAPABILITIES DURING DISORDERS/DISTURBANCES  
WITHIN DETAINEE OPERATIONS

4.B. TRAINING SUPPORT: THE US ARMY MP SCHOOL AT FORT LEONARD WOOD IS  
PREPARING A TRAINING SUPPORT PACKAGE THAT WILL BE USED BY ALL TRAINERS FOR  
PRE-DEPLOYMENT TRAINING.

5. FOR MORE INFORMATION CONTACT FORSCOM G3 TRAINING, LTC [REDACTED] DSN  
367-6303, OR CPT [REDACTED] DSN 367 [REDACTED]  
CPT [REDACTED]  
CPT, FA  
G3 Training  
FORSCOM HQ  
Comm:404 [REDACTED]  
DSN:367 [REDACTED]

Exemption 5 - deliberative process  
draft documents  
Exemptions 3+6 - names withheld

[REDACTED]  
**From:** [REDACTED] CPT - G3/5/7  
**Sent:** Monday, June 07, 2004 6:26 PM  
**To:** [REDACTED] - LTC G3  
**Subject:** FW: FORSCOM Tng Guidance: MI Interrogation Training Tasks  
**Follow Up Flag:** Follow up  
**Flag Status:** Flagged

This is the email i sent out; MAJ [REDACTED] is the SGS at USAIC and MAJ [REDACTED] is the S3 of 11th MI Bde.

-----Original Message-----

**From:** [REDACTED] CPT - G3/5/7  
**Sent:** Thursday, June 03, 2004 2:07 PM  
**To:** [REDACTED] MAJ TRADOC DCSOPS&T; [REDACTED] MAJ USAIC&FH [REDACTED] (E-mail); [REDACTED]@us.army.mil  
**Cc:** [REDACTED] FORSCOM, G2  
**Subject:** FORSCOM Tng Guidance: MI Interrogation Training Tasks

Sirs,

FORSCOM Tng is considering publishing the following training tasks in training guidance to all MI units with regards to interrogations pre-deployment training. Request you provide comments/additions/changes regarding these tasks:

- Introduction to Detainee Operations (OIF/OEFJTF GTMO Detainee Definitions)
- Communicate with Detainees (Muslim Cultural Awareness/Basic Mission-related Language Skills)
- Military Justice and Intelligence Law/Geneva Conventions (Humane Treatment of Detainees)
  - Apply Legal Principles of MI Law to Collection Operations
  - Apply the Laws of Land Warfare to Collections Operations
- Use an Interpreter
- Stress Management
- HIV/Universal Precautions within Detainee Operations
- Use of Force for Detainee and Interrogation Operations (DROE/TROE)
- Restraint Procedures for Detainees
- Personal Safety Awareness
- React to a Physical Attack using Unarmed Self Defense Techniques
- Respond to a Bomb Threat and/or a Bomb within Detainee Operations
- Accountability Procedures
- Escort Procedures within Detainee Operations
- Perform Security and Control Activities within Detainee Operations

Please submit responses to me NLT 041700 JUN 04. Thanks.

v/r

[REDACTED]  
CPT, AV  
FORSCOM G3/5/7 TRO  
COMM (404) [REDACTED]  
DSN 367-XXXX

"Military power wins battles, but spiritual power wins wars." General George C. Marshall

Next pg. withhold EX 5  
Draft MI Interrogation Tasks

11/4/2004

000986

940

[REDACTED]

From: [REDACTED] COL - G3-TR  
Sent: Tuesday, May 04, 2004 9:51 AM  
To: [REDACTED] Contractor - G3; [REDACTED] LTC G3; [REDACTED] - LTC G3  
Subject: FW: LESSONS FROM THE ABU PRISON

As we discussed ... Let's not dig into 1A unless asked for specific data from Cmd Grp/G3  
Let's focus on moving the baseline ind training thru DA G3, DA G1 and HRC(and TRADOC)...  
Also, I will ask TRADOC how they ensure DMOSQ of deploting individuals.

[REDACTED]

-----Original Message-----

From: [REDACTED], COL, CMD GRP [mailto:[REDACTED]@us.army.mil]  
Sent: Tuesday, May 04, 2004 9:33 AM  
To: Burns, Julian H. MG - DCS G-3/5/7  
Cc: [REDACTED] COL - G3-TR; [REDACTED] COL - PAO; [REDACTED] - COL;  
[REDACTED] COL - G1; [REDACTED] BG ARMY G-3/DAMO-TRZ; Kelley, James BG (USARC  
CMDGRP); [REDACTED] COL - G3; 78th Div (TS), CofS; [REDACTED] COL, DCS, G-3;  
[REDACTED] ADCS, G-3; [REDACTED] LTC, DCS, G-3; [REDACTED] LTC, DCS,  
G-3; Inge, Joseph R., LTG, CG; Huber, Keith M., MG, DCG; Garrison Cdr, Fort Dix; TSB  
Meade, CDR 5th Bde, 78th Div; TSB Bragg, CDR 4th Bde, 78th Div; 78th Div (TS), CG  
Subject: RE: LESSONS FROM THE ABU PRISON

Sir,

Have more folks than you can shake a stick at trying to contact TSBs and other folks involved in Post-MOB training for 372nd MP. To prevent a problem with multiple sources and to ensure integrity of information, especially considering the ongoing investigations, 1A is telling its subordinate units and MOBSTAs to forward all such official requests to this headquarters and we will be the sole source of this information. This only applies to Post-MOB training of this unit, not pre-MOB. Inquiries from media sources will be referred to HQDA PAO, per CG's discussion with the DAS yesterday. Once we have all applicable information, will forward to you directly. Would ask that you assist in our effort to ensure accurate information is provided to folks with a need to know.

v/r

[REDACTED]

Colonel, General Staff  
Chief of Staff, First U.S. Army  
(404) 469-[REDACTED] (DSN 797-)  
[REDACTED]@first.army.mil

FIRST IN DEED!

-----Original Message-----

From: Burns, Julian H. MG - DCS G-3/5/7 [mailto:Julian.Burns1@us.army.mil]  
Sent: Tuesday, May 04, 2004 8:16 AM  
To: Kelley, James A BG USARC CMDGRP; [REDACTED] COL - 1A CS; Weber, Louis W. BG ARMY G-3/DAMO-TRZ  
Cc: [REDACTED] COL - G3-TR; [REDACTED] COL - PAO; [REDACTED] - COL;  
[REDACTED] COL - G1; [REDACTED] COL - G3  
Subject: LESSONS FROM THE ABU PRISON

TEAM

TX FOR YOUR INPUTS

HERE IS THE SUM TOTAL OF WHAT WE HAVE ON THE ABU PRISON ISSUES

MOVING OUT TO WORK TO CORRECT, TO INCLUDE EXPANDING THE TRAINING EXPERIENCE AT CRC  
[REDACTED] (AS LEAD) AS SUGGESTED BY CSM [REDACTED]

JUST TO CROSS TALK...AND SYNCHRONIZE

TX  
[REDACTED]



Exemption 3+6 Names  
with the

[REDACTED]

---

**From:** HQDA DCS G-3 DAMO-TRZ-XO [DAMOTRZXO@hqda.army.mil]  
**Sent:** Wednesday, May 26, 2004 11:02 AM  
**To:** [REDACTED] LTC G3  
**Subject:** MA for Schlesinger Panel  
**Follow Up Flag:** Follow up  
**Flag Status:** Flagged

LTC [REDACTED]

Here is the original tasking that came through channels concerning the Schlesinger Panel. The panel is scheduled to meet in early June. Our tasking is simply to conduct a mission analysis of the attached memo to identify specified and implied tasks in preparation for questions when the panel is in session. These questions will likely be very short-fused and time sensitive.

The first page outlines "**training of regular and reserve personnel**," as the only real specified task. As I read the focus of the panel and the underlying intent, I would submit that the panel, and our responses, will likely focus on the specific training of the 800th MP Brigade and the MI Brigade during Pre and Post Mobilization, to include an assessment of how well they performed during this training. It would be impossible to anticipate every question the panel may send in our direction, however, the previous outline should gather the salient points of interest necessary to accurately respond to the pane in a timely manner.

If you have additional questions please feel free to contact me.

Thanks,

[REDACTED]

[REDACTED]  
LTC, EN  
Executive Officer  
Army Director of Training  
(703) [REDACTED]

<<Schelissenger Panel.pdf>>

11/5/2004

000989

FORSEMAN #52

943

Exemptions 3+6 names withheld  
Exemption 1 - information referred to 3A  
to review classification

[REDACTED]  
From: [REDACTED] LTC  
Sent: Tuesday, May 18, 2004 9:03 AM  
To: FORSCOM DCSOPS TNG CAT  
Subject: FW: MP Detainee Ops Training Guidance Question

Follow Up Flag: Follow up  
Flag Status: Flagged

For CPT [REDACTED]

Please incorporate into guidance

-----Original Message-----

From: [REDACTED] CFLCC/3A-FWD-C3  
Sent: Tuesday, May 18, 2004 7:39 AM  
To: [REDACTED] LTC  
Subject: RE: MP Detainee Ops Training Guidance Question

Classification: [REDACTED]  
Caveats: NONE

[REDACTED]

[REDACTED]

[REDACTED]

(b)(1)

-----Original Message-----

From: [REDACTED] LTC  
Sent: Tuesday, May 18, 2004 2:11 PM  
To: [REDACTED] CFLCC/3A-FWD-C3  
Cc: [REDACTED] COL, [REDACTED] LTC; FORSCOM DCSOPS TNG CAT  
Subject: MP Detainee Ops Training Guidance Question

Sir,

FORSCOM received a list of tasks for MP Detainee Ops training from CO [REDACTED] last week that has three tasks that are not contained in the LTG McKiernan white paper. They are:

- Escort Procedures within Detainee Operations
- Meal Operations within Detainee Camps
- Non-Lethal Capabilities during Disorder/Disturbances within Detainee Operations

We have captured all the tasks listed in the LTG McKiernan white paper in our training guidance, but wanted to verify with you if you wanted the 3 additional tasks included as well.

COL [REDACTED] is TDY, and asked that this request for clarification be sent to you.

VR

LTC [REDACTED]  
NIPRT [REDACTED]@forscom.army.mil  
SIPR [REDACTED]@force1.army.smil.mil  
DSN 367 [REDACTED] Comm 404 [REDACTED]

Classification: [REDACTED]  
Caveats: NONE

Exemptions 3+6 Names withheld  
Normally attachments would not be  
releasable however information  
already released

[Redacted]

**From:** [Redacted] COL  
**Sent:** Friday, May 07, 2004 7:13 AM  
**To:** [Redacted] LTC  
**Cc:** [Redacted] LTC; [Redacted] LTC  
**Subject:** FW: MP Information Papers

-----Original Message-----

**From:** Burns, Jr. Julian H. MG DCS G-3/5/7  
**Sent:** Friday, May 07, 2004 2:30 AM  
**To:** Louis W. BG ARMY G-3/DAMO-TRZ Weber (E-mail)  
**Cc:** Richard A. LTG Army G-3 Cody (E-mail); James J LTG DAS Lovelace (E-mail); McNeill, Dan K. LTG - CMD GRP; [Redacted] COL; [Redacted] - COL; Fred D MG Army G3/AOC Robinson (E-mail)  
**Subject:** MP Information Papers

Attached papers on 372nd MP CO, 320th MP BN and 800th MP BDE are provided per our discussion.



372 MP info  
paper.doc (30 KB)



320th MP  
FINAL.doc (30 KB)



800th MP BDE info  
paper.doc (3...

INFORMATION PAPER

Subject: Mobilization and training outline for the 372d Military Police Company

1. The 372d Military Police Company is home stationed at Cumberland, Maryland as part of the 99th Regional Readiness Command (U.S. Army Reserve). They were directed to mobilize in serial 187B to support Operation Iraqi Freedom as a Combat Support Military Police Company, with expected deployment to Silopi, Turkey. The unit reported to their mobilization station at Fort Lee, Virginia on 27 February 2003. On 29 March 2003, FRAGO 5 to DEPORD 187B was issued redirecting the unit to Kuwait as a Combat Support Military Police Company.
2. Mobilization Timeline:
  - a. Alert Date: 06 January 2003
  - b. Mobilization Date: 24 February 2003
  - c. Mobilization Station Arrival Date: 27 February 2003
  - d. Validation Date: 14 April 2003. Validated by the Fort Lee mobilization station commander at T-1.
  - e. Deployment Date: 13 May 2003
  - f. Duty Date: 14 May 2003
3. The unit was required and authorized 180 soldiers.
  - a. Unit arrived at Fort Lee with 180 soldiers.
  - b. Seventy-two of their soldiers had been assigned to the unit since their last annual training (AT).
  - c. Fifty-six of the remaining 108 soldiers had recently returned from a rotation on SFOR 10.
  - d. Ten soldiers were found not medically fit and did not deploy with the unit; 2 later deployed and joined the unit, 6 have already been released from active duty and 2 remain at Fort Lee as Medical Holds (one soldier is being medically separated and will leave in 1-2 weeks; the second Soldier's Medical Evaluation Board (MEB) packet will go to the Physical Evaluation Board (PEB) this week, will potentially be at Fort Lee for another 3-4 months).

e. Fifteen soldiers returned to Fort Lee during the deployment for administrative or medical reasons. Four have redeployed, one was given a Hardship Discharge (Chapter 6), nine were released from active duty and one remains at Fort Lee.

f. Thirty-four soldiers have returned from theater under the 730 day rule and have been released from active duty.

4. Mobilization station activities at Fort Lee and Fort Picket.

a. While mobilized at Fort Lee, the unit completed Soldier Readiness Processing (SRP), which included Medical, Dental, Personnel, Finance, Legal, and Security. All of the units' equipment received a technical inspection and was brought to fully mission capable condition (FMC). All soldiers were issued the required organizational clothing and individual equipment (OCIE) and Joint Service Lightweight Integrated Suit Technology (JSLIST).

b. As required by Forces Command, post mobilization training consisted of:

(1) FY03 Common Task Training Tasks (CTT) for Skill Level 1-4

(2) Individual Readiness Training (Cultural Awareness, Rules of Engagement (ROE), SAEDA, Media Awareness, and AT Level 1). The Rules of Engagement training included general information on the handling and treatment of prisoners.

(3) NBC Tasks

(4) First Aid Tasks

(5) Theater Specific Individual Requirements Training (TSIRT) Briefings (Nine Line Medical Evacuation (Medevac), Depleted Uranium, Force Protection, etc.)

(6) Weapons Qualification (Individual and Crew Served)

c. Collective training consisted of:

(1) Live Fire Exercise (M16/9MM)

(2) Dismounted Combat Maneuver

(3) Military Operations in Urban Terrain (MOUT) Training

d. The unit continued to conduct training after validation for deployment and the shipment of their equipment, however those training records were maintained by the unit.

## INFORMATION PAPER

Subject: Mobilization and Training Outline for the Headquarters and Headquarters Company, 320th Military Police Battalion, Enemy Prisoner of War, Counterintelligence, Detachment 2

1. The 320th Military Police Battalion, HHC, (EPW/CI), is home stationed at Ashley, Pennsylvania as part of the 800th Military Police Brigade and is subordinated to the 99th Regional Readiness Command (U.S. Army Reserve) in peacetime. Detachment 2 was directed to mobilize in serial 187B to support Operation Enduring Freedom as an Internment and Resettlement (IR) unit. Initial deployment duty location was identified as Tallil, Iraq. The unit reported to their mobilization station at Fort Dix, New Jersey on 19 February 2003, validated on 11 March 2003 and deployed on 13 March 2003. The unit returned to Fort Dix on 18 March 2004, demobilized and returned to their home station on 24 March 2004.

### 2. Mobilization Timeline:

- a. Alert Date: 1 January 2003
- b. Mobilization Date: 10 February 2003
- c. Mobilization Station Arrival Date: 19 February 2003
- d. Validation Date: 11 March 2003. Validated by Fort Dix mobilization station commander at T-1.
- e. Deployment Date: 13 March 2003
- f. Duty Date: 14 March 2003
- g. Redeployment Date: 18 March 2004

3. The unit was authorized 148 personnel. It was assigned 148 personnel. One soldier was placed on medical hold, three soldiers were placed on dental hold, and two additional soldiers were identified as nondeployable. The detachment deployed 142 soldiers.

### 4. Mobilization station activities at Fort Dix:

a. While mobilized at Fort Dix, the unit completed Soldier Readiness Processing (SRP), which included Medical, Dental, Personnel, Finance, Legal, and Security. All of the units' equipment received a technical inspection and was brought to fully mission capable condition

(FMC). All soldiers were issued the required organizational clothing and individual equipment (OCIE) and Joint Service Lightweight Integrated Suit Technology (JSLIST).

b. As required by Forces Command, post mobilization training consisted of:

(1) FY03 Common Task Training Tasks (CTT) for Skill Level 1-4

(2) Individual Readiness Training (Cultural and Religious Awareness, Rules of Engagement (ROE), SAEDA, Media Awareness, and AT Level 1). The Rules of Engagement training included general information on the handling and treatment of prisoners.

(3) NBC Tasks

(4) First Aid Tasks

(5) Theater Specific Individual Requirements Training (TSIRT) Briefings (Nine Line Medical Evacuation (Medevac), Depleted Uranium, Force Protection, etc.)

(6) Weapons Qualification (Individual and Crew Served)

c. Collective Training. Records indicate that the unit trained on the following collective tasks:

(1) Tactical Operations Center (TOC) Operations

(2) Battle Staff Training

d. Additionally records indicate that the unit was rated as a "P" in the following collective mission essential task list (METL) tasks upon arrival at the mobilization station.

(1) Establish and sustain an internment and resettlement facility

(2) Process and account for internees

(3) Anti terrorist and force protection operations

e. Due to theater requirements, the collective training of this unit was unusually compressed, with a total of 20 days available from arrival at the mobilization station to required validation date, including all soldier readiness processing (SRP) and individual and collective training.

INFORMATION PAPER

Subject: Mobilization and training outline for Detachment 3, Detachment 4, Detachment 6, Detachment 7, and Detachment 8 of the 800th Military Police Brigade

1. The 800th Military Police Brigade (EPW) deployed five detachments in support of operation Enduring Freedom to perform the duties of command and control for internment and resettlement military police assets. **Detachment (DET) 3**, home stationed at Hempstead, New York, mobilized eleven (11) soldiers in serial 174 for duty in Arifjan, Kuwait. The element reported to their mobilization station at Fort Dix, New Jersey on 05 January 2003. **Detachment (DET) 4**, home stationed at Hempstead, New York, mobilized three (3) soldiers in serial 177B1 to support Operation Enduring Freedom with duty in Arifjan, Kuwait. The unit reported to their mobilization station at Fort Dix, New Jersey on 19 January 2003. **Detachment (DET) 6**, home stationed at Uniondale, New York, mobilized forty three (43) soldiers in serial 177B1 to support Operation Enduring Freedom with duty in Arifjan, Kuwait. The unit reported to their mobilization station at Fort Dix, New Jersey on 19 January 2003. **Detachment (DET) 7**, home stationed at Hempstead, New York, mobilized twenty-one (21) soldiers in serial 187B to support Operation Enduring Freedom with duty in Tallil, Iraq. DET 7 reported to their mobilization station at Fort Dix, New Jersey on 21 January 2003. **Detachment (DET) 8** consisted of one commander, home stationed at Hempstead, New York, that was mobilized on 21 May 2003 and processed through the CONUS Replacement Center at Fort Benning, Georgia. Detachment 8 was the Brigade Commander. The 800<sup>th</sup> Military Police Brigade is a peacetime subordinate unit of the 77th Regional Readiness Command (U.S. Army Reserve).

2. Mobilization Timeline:

a. 800th MP BDE (EPW) DET 3

- (1) Alert Date: 14 December 2002
- (2) Mobilization Date: 02 January 2003
- (3) Mobilization Station Arrival Date: 05 January 2003
- (4) Validation Date: 15 January 2003. Validated by the Fort Dix mobilization station commander at T-1.
- (5) Deployment Date: 26 January 2003
- (6) Duty Date: 27 January 2003



b. 800th MP BDE (EPW) DET 4

- (1) Alert Date: 01 November 2001
- (2) Mobilization Date: 16 January 2003
- (3) Mobilization Station Arrival Date: 19 January 2003
- (4) Validation Date: 27 January 2003. Validated by the Fort Dix mobilization station commander at T-1.
- (5) Deployment Date: 20 February 2003
- (6) Duty Date: 21 February 2003

c. 800th MP BDE (EPW) DET 6

- (1) Alert Date: 01 November 2001
- (2) Mobilization Date: 16 January 2003
- (3) Mobilization Station Arrival Date: 19 January 2003
- (4) Validation Date: 11 February 2003. Validated by the Fort Dix mobilization station commander at T-1.
- (5) Deployment Date: 20 February 2003
- (6) Duty Date: 21 February 2003

d. 800th MP BDE (EPW) DET 7

- (1) Alert Date: 01 November 2001
- (2) Mobilization Date: 10 February 2003
- (3) Mobilization Station Arrival Date: 21 February 2003
- (4) Validation Date: 04 June 2003. Validated by Fort Dix mobilization station commander at T-2.
- (5) Deployment Date: 08 June 2003
- (6) Duty Date: 09 June 2003

000997

e. 800th MP BDE (EPW) DET 8

(1) Alert Date:

(2) Mobilization Date: 21 May 2003

(3) Mobilization Station Arrival Date: 08 June 2003

(4) Validation Date: 13 June 2003. Validated by the Fort Benning mobilization station commander. No "T" rating since individual mobilized at CRC.

(5) Deployment Date: 18 June 2003

(6) Duty Date: 19 June 2003

3. The unit manning requirements:

a. 800th MP BDE (EPW) DET 3--The unit was authorized 12 personnel. It was assigned 11 personnel. The detachment deployed 11 soldiers.

b. 800th MP BDE (EPW) DET 4--The unit was authorized 3 personnel. It was assigned 3 personnel. The detachment deployed 3 soldiers.

c. 800th MP BDE (EPW) DET 6--The unit was authorized 43 personnel. It was assigned 43 personnel. Three (3) were medical holds, pending medical review, and one soldier was non-deployable. The detachment deployed 39 soldiers.

d. 800th MP BDE (EPW) DET 7--The unit was authorized 24 personnel. It was assigned 25 personnel. Three (3) were medical holds, pending medical review, one soldier was non-deployable. The detachment deployed 21 soldiers.

e. 800th MP BDE (EPW) DET 8--The unit was authorized 1 Cdr. It was assigned and deployed 1 soldier.

4. Mobilization station activities at Fort Dix and Fort Benning:

a. Units mobilized at Fort Dix completed Soldier Readiness Processing (SRP), which included Medical, Dental, Personnel, Finance, Legal, and Security. All soldiers were issued the required organizational clothing and individual equipment (OCIE) and Joint Service Lightweight Integrated Suit Technology (JSLIST).

b. As required by Forces Command, post mobilization training consisted of:

(1) Individual Readiness Training (Cultural and Religious Awareness, Rules of Engagement (ROE) and Rule for Use of Force (RUF), SAEDA, Media Awareness, and Anti

terrorism (AT) Level 1, Reaction to indirect fire, Mine awareness, and Risk Management / Assessment).

(2) NBC Tasks

(3) First Aid Tasks / Combat Life Saver

(4) Theater Specific Individual Requirements Training (TSIRT) Briefings

(5) Weapons Qualification

c. Mobilization of unit in small detachments did not support collective training of 800<sup>th</sup> Military Police Brigade Headquarters.

d. The Commander processing through the CONUS replacement center at the Fort Benning was trained in the following tasks: Rules of Engagement, Protective Mask Fitting, Biological/Chemical Warfare Prevention & Protective Measures, Country Overview/Anti-Terrorism, Medical Threat Brief, Preliminary Marksmanship Instruction, Individual Weapons Qualification, Improvised Explosive Devices, Unexploded Ordnance, and Subversion and Espionage Directed against the Army (SAEDA)/Operations Security.

Exemptions 3+6 - names with the  
Attached draft statement - not  
(3 PAGES) released  
EX 5

[REDACTED]

**From:** [REDACTED] COL - G3-TR  
**Sent:** Wednesday, May 12, 2004 10:05 AM  
**To:** [REDACTED] Contractor - G3; [REDACTED] LTC G3; [REDACTED] LTC G3  
**Subject:** FW: POW Abuse Statement C2

What do you think?

-----Original Message-----

**From:** [REDACTED] COL - PAO  
**Sent:** Monday, May 10, 2004 5:46 PM  
**To:** Burns, Julian H. MG - DCS G-3/5/7  
**Cc:** [REDACTED] COL - SJA; [REDACTED] COL - G3-TR; [REDACTED] LTC - G1  
**Subject:** POW Abuse Statement C2

Sir,

FYI.

Colonels: Please review and comment on proposed RTQ and Q and A. First cut.

[REDACTED]



POW Abuse  
Statement C2.doc

→ 3 pgs not released  
EX 5 - DRAFT

Exemption 3b Name withheld  
Ordinarily would not release attached  
information; however, has already  
been released by higher.

[REDACTED]

**From:** [REDACTED] LTC - G3  
**Sent:** Saturday, June 05, 2004 2:09 PM  
**To:** [REDACTED] COL - G3-TR  
**Cc:** [REDACTED] - LTC G3 [REDACTED] - LTC G3 [REDACTED] - LTC - G3 [REDACTED]  
**Subject:** [REDACTED] LTC - G3  
OIF Detainee Ops and OIF Training Guidance, change 3

**Follow Up Flag:** Follow up  
**Flag Status:** Flagged

Sir,

Slides as requested - OIF Detainee operations and updated OIF Training Guidance, change 3.

In COL [REDACTED] paper he recommends specific tasks be integrated prior to TOA for skill level one training received at MP OSUT. Those tasks and all other recommended tasks are included in the FORSCOM message.



OIF Detainee  
Operations.ppt



OIF Tng Guidance  
Change 3.ppt

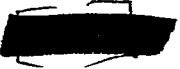

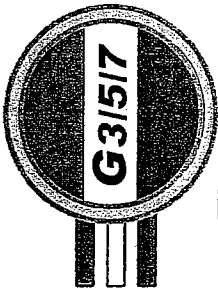

# OIF Detainee Operations

## Theater Specific Internment and Detainee Operations Collective Tasks

- Introduction to Detainee Operations (OIF Detainee Definitions)
- Communicate with Detainees (Muslim Cultural Awareness)
- Geneva Conventions (Human Treatment of Detainees)
- Stress Management
- HIV / Universal Precautions within Detainee Operations
- Use of Force for Detainee and Interrogation Operations (DROE / IROE)
- Detainee Frisk, Undress, Cell and Area Search Procedures
- Restraint Procedures for Detainees
- Personal Safety Awareness
- React to a Physical Attack Using Unarmed Self Defense Techniques
- Forced Cell Move (FCM) Procedures
- Respond to a Bomb Threat and/or a Bomb within Detainee Operations
- Emergency Actions for Fire, Escapes and Disorders within Detainee Facilities
- Cell Block Operations within a Detainee Camp
- Accountability Procedures
- Perform Security and Control Activities within Detainee Operations
- Special Housing Unit (SHU) / Segregation Operations
- Main Gate / Sally Port Operations
- Visitation Procedures
- Biometric Automated Toolset Systems (BATS) and National Detainee Reporting System (NDRS)
- Capabilities and Limitations of the Interrogation
- Support Relationships between Military Police and Military Intelligence in Detainee Operations
- Humane Treatment of Detainees
- International Agreements and Regulations Relating to Detainees
- Integration of Procedures for Evacuation, Control, and Administration of Detainees
- Escort Procedures within Detainee Operations
- Non-lethal Weapons Capabilities During Disorders / Disturbances within Detainee Operations

001002

UNCLAS

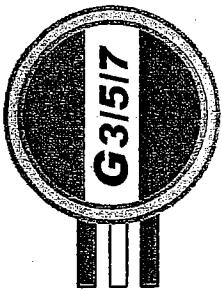

# OIF Training Tasks

## Stability Operations

- Leader Tasks/Training
  - Understand the military, political, cultural, economic, and religious environment.
  - Utilize an Interpreter
  - Perform Negotiations
  - Supervise Convoy Operations
  - Employ Non-Lethal (NL) Capabilities
  - Plan and Conduct Urban Operations
  - Supervise ROE
  - Use of Graduated Response
  - Conduct CASEVAC
  - Risk management
  - Supervise Traffic Control
  - Cordon and Search
  - UXOs/IEDs
  - Crowd Control
- Squad/ Platoon
  - Traffic Control Point Operations
    - Conduct a personnel search.
    - Conduct a vehicle search
  - Observation Post Operations
  - Convoy Operations (platoon only)
  - Quick Reaction Force Ops (platoon only)
  - Cordon and Search (platoon only)
  - Urban Operations (platoon only)
- Company
  - Convoy Operations
  - Quick Reaction Force Operations.
  - Cordon and Search
  - Urban Operations
  - Establish/Operate a Company CP
  - Information Operations
- Battalion/Task Force
  - Liaison with Outside Agencies
  - Quick Reaction Force Ops
  - Force Protection
  - Information Operations
  - Convoy Operations
  - Media Relations
  - Conventional/SOF Coordination
- Brigade
  - Force Protection
  - Liaison with Outside Agencies
  - Information Operations
  - Liaison with Coalition forces

Source: OIF Training Guidance Change 3, 5 JUN 04

UNCLAS

FORSCOM

001003

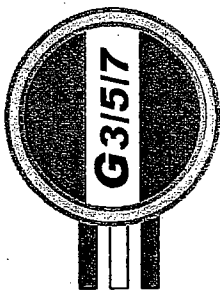

# OIF Training Tasks

## Combat Operations

- Individual tasks (as required)
  - CTT
  - Land Navigation
  - Individual movement techniques
  - Troop leading procedures
  - UXO TTP
  - IED Recognition TTP
  - Counter Sniper Operations
  - Law of War (Geneva & Hague Conventions)
  - Army Values
  - CFLCC Rules for Use of Force
- Crew/Team/Squad
  - Conduct Troop Leading Procedures
  - Team/squad movement
  - Crew served weapons gunnery
  - Squad attack
  - Conduct Link up
  - Patrolling TTP
  - Combat Life Saver
  - IED Recognition and TTPs
  - MOUT squad lane
  - React to Sniper
- Platoon
  - Formations
  - Cross danger area
  - Deliberate attack
  - Actions on contact
  - Employ/reduce obstacles
  - Break contact
  - React to ambush
  - React to Sniper
  - Knock out bunker
  - Assault Building
  - Initial breach of wire/mine/obstacle
  - Enter/Clear trench
  - Heavy/Lt-Ops
  - MOUT
  - Convoy Operations
  - Raid
  - Ambush
- Company
  - Convoy Operations
  - Hasty & Deliberate defense
  - Counter recon
  - Hasty Attack / Assault
  - Clear trench
  - Employ QRF
  - Breach
  - Advance Guard
  - Support by Fire
  - Heavy/Light Op
  - MOUT
  - Air Ground Coordination
- Battalion
  - Defense in Sector
  - Deliberate Attack
  - Movement to Contact
  - Raid
  - Plan Operations Using the MDMP
  - Air Ground Coordination
- Brigade
  - Conduct Command and Control Operations
  - MDMP/BCBST (BDE CMD Battle Staff TNG)
    - Deliberate Defense (SIM)
    - Movement to Contact (SIM)
    - Deliberate Attack (SIM)
  - Stability & Support Ops Urban Environment LTP/CPX
  - Air Ground Coordination
  - Coalition Synchronization Operations
  - LNO's
  - Cross TNG, Force Prot., ROE, Fire Coord.
  - Logistics Support Operations

Source: OIF Training Guidance Change 3, 5 JUN 04

UNCLAS

FORSCOM

001004

958



Duplicate  
Exemptions 376 names withheld

[REDACTED]

**From:** [REDACTED] COL  
**Sent:** Wednesday, September 15, 2004 6:16 PM  
**To:** Burns, Julian H. MG - DCS G-3/5/7  
**Cc:** [REDACTED] Enright, John L. BG (DIRMOBFOR) [REDACTED] LTC G3 [REDACTED] LTC - G3  
**Subject:** FW: Taskers for OCAR, JS and FORSCOM (UNCLASSIFIED)  
**Importance:** High

Sir,  
Request guidance on DA tasker for information on three Afghanistan units involved in detainee operations.

[REDACTED]  
 Chief of Training, FORSCOM  
 404 [REDACTED] (DSN 367)  
 npr: [REDACTED]@forscom.army.mil  
 sipr: [REDACTED]@force1.army.smil.mil

-----Original Message-----

**From:** [REDACTED] - LTC G3  
**Sent:** Wednesday, September 15, 2004 5:24 PM  
**To:** [REDACTED] COL  
**Cc:** [REDACTED] LTC - G3 [REDACTED] LTC G3  
**Subject:** FW: Taskers for OCAR, JS and FORSCOM (UNCLASSIFIED)  
**Importance:** High

Sir,

Received attached tasking from LTC [REDACTED] DA G3. Tasking from their ECC. Requesting information on the three detainee units deployed to Afghanistan in 2002 (previous email). Recommend notifying MG Burns and seeking guidance/permission to prepare a response.

-----Original Message-----

**From:** [REDACTED] LTC HQDA DCS G-3/5/7 [mailto:[REDACTED]@us.army.mil]  
**Sent:** Wednesday, September 15, 2004 5:14 PM  
**To:** [REDACTED] G3  
**Cc:** [REDACTED] IAJ G3  
**Subject:** FW: Taskers for OCAR, JS and FORSCOM (UNCLASSIFIED)  
**Importance:** High

Tasker from HQDA ECC request for response from FORSCOM. To go with what I sent you earlier today. If you have completed this, CC me with your response for my records.

Thanks again!!!!

v/r  
[REDACTED]

-----Original Message-----

**From:** [REDACTED] LTC ECC  
**Sent:** Wednesday, September 15, 2004 5:05 PM  
**To:** [REDACTED] LTC HQDA DCS G-3/5/7  
**Subject:** FW: Taskers for OCAR, JS and FORSCOM (UNCLASSIFIED)

Classification: UNCLASSIFIED  
Caveats: FOUO

Here is what I tasked. Verify wheter or not this is what you needed.

v/r  
[REDACTED]

-----Original Message-----

**From:** [REDACTED] M LTC ECC  
**Sent:** Friday, September 03, 2004 5:47 AM  
**To:** [REDACTED] COL HQDA DCS G-3/5/7; [REDACTED] COL (OCAR-ZX); [REDACTED] COL NGB-ARR; [REDACTED] COL, FORSCOM  
Secretary of the General Staff  
**Cc:** [REDACTED] COL ECC; [REDACTED] LTC VDAS  
**Subject:** FW: Taskers for OCAR, JS and FORSCOM (UNCLASSIFIED)

Classification: UNCLASSIFIED  
Caveats: FOUO

Sirs/Ma'am,

Here are some short fused quick turn around taskers that I'm sending to you ASAP - see the word document below in reference to Detainee Operations. I will formally put into the HQDA tracking system this morning but please don't wait to begin executing. We need these for the Senior Army Leadership as well as for OSD. I will resolve suspenses this morning with the Detainee TF at our 0730 meeting.

v/r  
[REDACTED]

LTC [REDACTED]  
OCSA-ECC-HR  
(703) 697-[REDACTED]  
NIPR: [REDACTED]@hqda.army.mil  
SIPR: [REDACTED]@hqda.army.smil.mil

-----Original Message-----

**From:** [REDACTED] DAS  
**Sent:** Thursday, September 02, 2004 7:05 PM  
**To:** [REDACTED] LTC ECC  
**Cc:** [REDACTED] COL ECC; [REDACTED] AS; [REDACTED] LTC HQDA DCS G-3/5/7; [REDACTED] AJ PMG  
**Subject:** Taskers for OCAR, JS and FORSCOM (UNCLASSIFIED)

Classification: UNCLASSIFIED

Caveats: FOUO

[REDACTED] the attached RFIs need to be tasked as we discussed.

<<2 Sept Joint Staff, OCAR and FORSCOM RFIs.doc>>

R. [REDACTED]

[REDACTED]  
LTC, GS  
Action Officer  
Executive Office of the Headquarters  
Office of the Vice Director of the Army Staff  
703-695-[REDACTED]

Classification: UNCLASSIFIED

Caveats: FOUO

Classification: UNCLASSIFIED

Caveats: FOUO

<<2 Sept Joint Staff, OCAR and FORSCOM RFIs.doc>>

Classification: UNCLASSIFIED

Caveats: FOUO

Exemptions 3+6 names withheld  
Exemption 5 - deliberative process  
Exemption 1 - classified information redacted and referred to 3A for classification review.  
Normally would request training tasks be redacted however already publically released

[REDACTED]  
From: [REDACTED] - LTC  
Sent: Friday, August 20, 2004 9:21 AM  
To: [REDACTED] CFLCC/3A-ATL-C3  
Cc: [REDACTED] - LTC [REDACTED] LTC [REDACTED] LTC  
Subject: FW: Training Documents  
Follow Up Flag: Follow up  
Flag Status: Flagged

[REDACTED]

B5

Thanks

-----Original Message-----

From: [REDACTED] LTC  
Sent: Friday, August 20, 2004 8:17 AM  
To: [REDACTED] LTC  
Cc: [REDACTED] DL  
Subject: FW: Training Documents

[REDACTED]  
Theater request to add additional Detention Ops predeployment training requirements.

-----Original Message-----

From: [REDACTED] MAJ CFLCC/3A-FWD-C3  
Sent: Friday, August 20, 2004 11:02 AM  
To: [REDACTED] LTC CFLCC/3A-ATL-C3; [REDACTED] LTC  
Cc: [REDACTED] LTC CFLCC/3A-FWD-C3 TNG [REDACTED] LTC MNC-I C35 Force Gen  
Subject: FW: Training Documents

Classification: [REDACTED]

Caveats: NONE

[REDACTED]

[REDACTED]

B.1

962

v/r

MAJ, GS  
C3 Training Operations Officer  
CFLCC C3 FWD  
318-430-5088

**From:** [redacted] LTC CFLCC/3A-FWD-C3 Plans  
**Sent:** Friday, August 20, 2004 10:28 AM  
**To:** [redacted]  
**Cc:** [redacted] MAJ CFLCC/3A-FWD; [redacted]  
**Subject:** FW: Training Documents

Classification: [redacted]

Caveats: NONE

[redacted]

81

Vr [redacted]

LTC [redacted]  
CFLCC C3 Plans (Kuwait)  
DSN 318 [redacted]

-----Original Message-----

**From:** [redacted] LTC MNC-I C35 Force Gen.  
**Sent:** Friday, August 20, 2004 12:18 PM  
**To:** [redacted] COL MNC-I C3 Chief Of Ops; [redacted] COL MNC-I C3 CHOPS; [redacted]  
MAJ MNC-I C5 PLANNER; [redacted] COL MNC-I C3; [redacted] COL C3; [redacted] CFLCC C3  
FUOPS; [redacted] LTC CFLCC/3A-FWD-C3 Plans; [redacted] MAJ CFLCC/3A-FWD-C3; [redacted]  
[redacted] MAJ CFLCC/3A-ATL-C5; [redacted] COL CFLCC/3A-FWD C3; [redacted] MAJ CFLCC/3A-ATL-  
G3; [redacted] GM CFLCC/3A-FWD-377 TSC G-4; [redacted] MAJ CFLCC/3A-ATL-G3; [redacted]  
[redacted] MAJ CFLCC/3A-FWD-C3; [redacted] LTC CFLCC/3A-ATL-C5; [redacted] CFLCC/3A-FWD C-3  
Future Plans  
**Subject:** FW: Training Documents

Please pass to the trainers. Enclosed is MG Miller, Detention OPS recommendation to the training program.

LTC [redacted]  
MNC-I C35 (Force Generation)  
DSN 318-822 [redacted]

-----Original Message-----

**From:** [redacted] MAJ MNC-I C5 PLANNER  
**Sent:** Thursday, August 19, 2004 11:22 AM  
**To:** [redacted] LTC MNC-I C35 Force Gen.  
**Subject:** Training Documents

Sir: As requested. V/R [redacted]

Classification: [REDACTED]

Caveats: NONE

Attachment Classification: [REDACTED]

Attachment Caveats: NONE

Classification: [REDACTED]

Caveats: NONE



REPLY TO  
ATTENTION OF

HEADQUARTERS  
MULTI-NATIONAL FORCE - IRAQ  
OFFICE OF THE DCG-DO  
BAGHDAD, IRAQ  
APO AE 09342-1400

MNFI-CD

12 August 2004

MEMORANDUM FOR C3, MNFI

SUBJECT: Non 31E MP/ILO Pre-Deployment Training Requirements for the Iraqi Theater of Operations

1. Based on a comprehensive review of the 31E / Military Police - Internment/Resettlement Specialist task set and the unique considerations present in this theater for MP / ILO nominated OIF 2/3 units and Individual Augmentees (IAs), we have identified theater (Iraq) specific pre-deployment training requirements for detainee operations. (See enclosure). The task set represents the minimum number of 31E related tasks and other recommended supporting tasks requiring validation during the mobilization process and is in addition to other mandated subject matter / topics required for deployment to the Iraqi theater.
2. Request DIRLAUTH with FORSCOM relative to the deployment cycle training requirements for MPs and ILO MPs identified for duty in the Iraqi theater.
3. MP / ILO units and IAs arriving in support of OIF 2/3 must be trained to standard in the unique task set required in detainee operations in order to facilitate the effective transfer of operations during the rotation of forces without degradation of operational capabilities.
4. Please direct questions regarding this memorandum to the LTC [REDACTED], Detainee Operations at DSN 822 [REDACTED] or e-mail at [REDACTED]@iraq.centcom.smil.mil.

Encl (1)

  
GEOFFREY D. MILLER  
MG, USA  
Deputy Commanding General  
Detainee Operations

001011

## Non 31E MPs/ILO MPs Pre-Deployment Training Task Set

Task	Reference
1. Introduction to Detainee Operations	USAMPS CD 202
2. Perform security and control activities at a detainee camp	USAMPS CD 226
3. Apply priorities of force within a detainee camp	Task 191-381-1324
4. Conduct inspections/shakedowns of detainee areas	Task 191-381-1251
5. Observe detainees in close confinement	Task 191-381-1317
6. Control recreation, shower and shave call within close confinement	Task 191-381-1319
7. Inspect physical security of a Detainee Camp (tents and barracks area)	Task 191-382-2347
8. Interact with detainees	Task 191-381-1290/ USAMPS CD 206
9. Restrain a detainee	Task 191-381-1255/ USAMPS CD 250
10. Detect symptoms of unusual or potentially deviant behaviors of detainees	Task 191-381-1291
11. Control vehicle entry to and exit from a detainee camp	Task 191-381-1304
12. Control packages and materials at sally port	Task 191-381-1305/ USAMPS CD 404
13. Control personnel entry to and exit from a detainee camp	Task 191-381-1306
14. Control detainee movements within a detainee camp	Task 191-381-1332
15. Frisk search a detainee	Task 191-381-1287
16. Perform a forced removal of a detainee	Task 191-381-1861
17. Account for detainees	Task 191-382-2290
18. Brief detainee escorts / escort procedures	USAMPS CD 246
19. Prepare observation and disciplinary reports	Task 191-381-1323
20. Supervise and control procedures during detainee meals	Task 191-382-2348
21. Prepare a DA Form 2823 (Sworn Statement)	Task 191-376-0002
22. Prepare a DA Form 4137 (Evidence/Property Custody Document)	Task 191-376-5138
23. Identify evidence/contraband	Task 191-376-5124
24. Collect evidence	Task 191-376-5125
25. Unarmed Self-Defense (Pressure Point Control Techniques)	USAMPS CD 260
26. Stress Management	USAMPS CD 208
27. Geneva Convention (Humane Treatment of Detainees)	USAMPS CD 113
28. HIV and Universal Precautions	USAMPS CD 216



29.	*Full Spectrum of Use of Force to include: Verbal persuasion Less than Lethal Weapons -Proper use and operation of a Taser (SEL Indiv) -OC (All) -12 Gauge Shotgun (less than lethal munitions – M1013, M1012, 40mm non-lethal and 40mm 1029) *(Incorporate ROE for Iraq)	USAMPS CD 252 (Use of Force), CD 500 (Non-Lethal Weapons) Task 191-381-1294
30.	Emergency Action for Fire, Escapes and Disorders within Detainee Operations	USAMPS CD 254
31.	Special Housing Unit Procedures within Detainee Operations	USAMPS CD 410
32.	React to a bomb threat and/or bomb in a detainee camp	Task 191-381-1250
33.	Supervise and control processes in order to ensure compliance with 3 and 4 of the Geneva Convention	
34.	Personal safety awareness	USAMPS CD 228
35.	Perform as a Tower Guard	Task 191-381-1302
36.	Participate in Riot Control Formations to Control Internees	Task 191-381-1258
37.	Take Action in the Event of Disorder at an Internment Facility	Task 191-381-1321

Additional Recommended Tasks:

- A. Cultural awareness (Islam and Iraq)
- B. Interpersonal communication (IPC) Skills
- C. Maintain Operations Security (OPSEC)
- D. Behavioral Health Sciences (BHS) training
- E. Civil Disturbance (CD) training
- F. Segregation measures
- G. Storage of evidence
- H. Identification of suspicious activity
- I. React to Direct and Indirect Fires

[REDACTED]  
From: [REDACTED] - LTC G3  
Sent: Friday, May 14, 2004 12:32 PM  
To: [REDACTED] CPT - G3  
Subject: FW: "training" extract

Follow Up Flag: Follow up  
Flag Status: Flagged

[REDACTED] ... more information on the MP training guidance

LTC [REDACTED]  
G3 Training  
DSN 367 [REDACTED] Comm 404-464 [REDACTED]

-----Original Message-----

From: [REDACTED] COL - G3-TR  
Sent: Wednesday, May 12, 2004 6:20 AM  
To: [REDACTED] LTC G3  
Subject: FW: "training" extract

[REDACTED]

See recommendations from MG Taguba report below ... Ensure our new guidance is consistent  
. Thanks,

[REDACTED]

-----Original Message-----

From: Burns, Julian H. MG - DCS G-3/5/7  
Sent: Tuesday, May 11, 2004 9:10 AM  
To: [REDACTED] COL - PAO  
Cc: [REDACTED] COL - G3-TR; [REDACTED] COL; [REDACTED] COL - SJA  
Subject: RE: "training" extract

Recommend cross talk with the conusa, cc'd here  
Burns

-----  
Sent from my BlackBerry Wireless Handheld

-----Original Message-----

From: [REDACTED] COL - PAO [REDACTED]@forscom.army.mil>  
To: Burns, Julian H. MG - DCS G-3/5/7 <Julian.Burns1@us.army.mil>  
Sent: Tue May 11 09:08:11 2004  
Subject: RE: "training" extract

Roger. I am coordinating at light speed. Note the comment by General Helmly below. This helps.

"I believe that members of this unit had the requisite training to ensure that they were aware of and competent in the task needed to secure enemy prisoners of war, and to ensure that they were aware of the requirement for humane treatment of prisoners," Gen. Helmly said.

The Army also has said that all soldiers, regardless of job assignments, learn about the Geneva Conventions prohibiting mistreatment of prisoners of war and others.

-----Original Message-----

From: Burns, Julian H. MG - DCS G-3/5/7

Sent: Tuesday, May 11, 2004 8:04 AM

To: [REDACTED] COL - PAO

Cc: [REDACTED] COL - G3-TR [REDACTED] LTC - G1 [REDACTED] COL - SJA

Subject: Re: "training" extract

Tx

Sent from my BlackBerry Wireless Handheld

Ex 5

-----Original Message-----

From: [REDACTED] COL - PAO [REDACTED]@forscom.army.mil>

To: Burns, Julian H. MG - DCS G-3/5/7 <Julian.Burns1@us.army.mil>

CC: [REDACTED] COL - G3-TR [REDACTED]@us.army.mil> [REDACTED] LTC - G1

[REDACTED]@forscom.army.mil>; [REDACTED] COL - SJA

[REDACTED]@us.army.mil>

Sent: Tue May 11 09:00:16 2004

Subject: FW: "training" extract

Sir, FYI only. The Taguba report w/ specific training issues highlighted.

-----Original Message-----

From: [REDACTED] PAO

Sent: Tuesday, May 11, 2004 7:23 AM

To: [REDACTED]

Cc: [REDACTED] 2; [REDACTED] [REDACTED] [REDACTED]

Subject: "training" extract

Importance: High

These are taken out of the various sections and thus the numbering is not in order. I am printing the entire report minus annexes.

Deputy Chief of Public Affairs

404-[REDACTED] / dsn 367 [REDACTED]

(U) The 800th MP (I/R) units did not receive Internment/Resettlement (I/R) and corrections specific training during their mobilization period. Corrections training is only on the METL of two MP (I/R) Confinement Battalions throughout the Army, one currently serving in Afghanistan, and elements of the other are at Camp Arifjan, Kuwait. MP units supporting JTF-GTMO received ten days of training in detention facility operations, to include two days of unarmed self-defense, training in interpersonal communication skills, forced cell moves, and correctional officer safety. (ANNEX 19)

(U) The 800th MP Brigade has experienced challenges adapting its task organizational structure, training, and equipment resources from a unit designed to conduct standard EPW operations in the COMMZ (Kuwait). Further, the doctrinally trained MP Soldier-to-detainee population ratio and facility layout templates are predicated on a compliant, self-disciplining EPW population, and not criminals or high-risk security internees. (ANNEX 19)

12. (U) I find that prior to its deployment to Iraq for Operation Iraqi Freedom, the 320th MP Battalion and the 372nd MP Company had received no training in detention/internee operations. I also find that very little instruction or training was provided to MP personnel on the applicable rules of the Geneva Convention Relative to the Treatment of Prisoners of War, FM 27-10, AR 190-8, or FM 3-19.40. Moreover, I find that few, if any, copies of the Geneva Conventions were ever made available to MP personnel or detainees. (ANNEXES 21-24, 33, and multiple witness statements)

RECOMMENDATIONS AS TO PART ONE OF THE INVESTIGATION:

1. (U) Immediately deploy to the Iraq Theater an integrated multi-discipline Mobile

Training Team (MTT) comprised of subject matter experts in internment/resettlement operations, international and operational law, information technology, facility management, interrogation and intelligence gathering techniques, chaplains, Arab cultural awareness, and medical practices as it pertains to I/R activities. This team needs to oversee and conduct comprehensive training in all aspects of detainee and confinement operations.

2. (U) That all military police and military intelligence personnel involved in any aspect of detainee operations or interrogation operations in CJTF-7, and subordinate units, be immediately provided with training by an international/operational law attorney on the specific provisions of The Law of Land Warfare FM 27-10, specifically the Geneva Convention Relative to the Treatment of Prisoners of War, Enemy Prisoners of War, Retained Personnel, Civilian Internees, and Other Detainees, and AR 190-8.

10. (U) Camp Bucca, operated by the 310th MP Battalion, had a "Criminal Detainee In-Processing SOP" and a "Training Outline" for transferring and releasing detainees, which appears to have been followed. (ANNEXES 38 and 52)

Several detainees allegedly began to riot at about 1300 in all of the compounds at the Ganci encampment. This resulted in the shooting deaths of 3 detainees, 9 wounded detainees, and 9 injured US Soldiers. A 15-6 investigation by COL Bruce Falcone (220th MP Brigade, Deputy Commander) concluded that the detainees rioted in protest of their living conditions, that the riot turned violent, the use of non-lethal force was ineffective, and, after the 320th MP Battalion CDR executed "Golden Spike," the emergency containment plan, the use of deadly force was authorized. Contributing factors were lack of comprehensive training of guards, poor or non-existent SOPs, no formal guard-mount conducted prior to shift, no rehearsals or ongoing training, the mix of less than lethal rounds with lethal rounds in weapons, no AARs being conducted after incidents, ROE not posted and not understood, overcrowding, uniforms not standardized, and poor communication between the command and Soldiers. (ANNEX 8)

#### FINDINGS AND RECOMMENDATIONS (PART THREE)

(U) Investigate the training, standards, employment, command policies, internal procedures, and command climate in the 800th MP Brigade, as appropriate: (Names deleted). (ANNEXES 45-91) REGARDING PART THREE OF THE INVESTIGATION, I MAKE THE FOLLOWING SPECIFIC FINDINGS OF FACT: 1. (U) I find that BG Janis Karpinski took command of the 800th MP Brigade on 30 June 2003 from BG Paul Hill. BG Karpinski has remained in command since that date. The 800th MP Brigade is comprised of eight MP battalions in the Iraqi TOR: 115th MP Battalion, 310th MP Battalion, 320th MP Battalion, 324th MP Battalion, 400th MP Battalion, 530th MP Battalion, 724th MP Battalion, and 744th MP Battalion. (ANNEXES 41 and 45) 2. (U) Prior to BG Karpinski taking command, members of the 800th MP Brigade believed they would be allowed to go home when all the detainees were released from the Camp Bucca Theater Internment Facility following the cessation of major ground combat on 1 May 2003. At one point, approximately 7,000 to 8,000 detainees were held at Camp Bucca. Through Article-5 Tribunals and a screening process, several thousand detainees were released. Many in the command believed they would go home when the detainees were released. In late May-early June 2003 the 800th MP Brigade was given a new mission to manage the Iraqi penal system and several detention centers. This new mission meant Soldiers would not redeploy to CONUS when anticipated. Morale suffered, and over the next few months there did not appear to have been any attempt by the Command to mitigate this morale problem. (ANNEXES 45 and 96) 3. (U) There is abundant evidence in the statements of numerous witnesses that soldiers throughout the 800th MP Brigade were not proficient in their basic MOS skills, particularly regarding internment/resettlement operations. Moreover, there is no evidence that the command, although aware of these deficiencies, attempted to correct them in any systemic manner other than ad hoc training by individuals with civilian corrections experience. (Multiple Witness Statements and the Personal Observations of the Investigation Team) 4. (U) I find that the 800th MP Brigade was not adequately trained for a mission that included operating a prison or penal institution at Abu Ghraib Prison Complex. As the Ryder Assessment found, I also concur that units of the 800th MP Brigade did not receive corrections-specific training during their mobilization period. MP units did not receive pinpoint assignments prior to mobilization and during the post mobilization training, and thus could not train for specific missions. The training that was accomplished at the mobilization sites were developed and implemented at the company level with little or no direction or supervision at the Battalion and Brigade levels, and consisted primarily of common tasks and law enforcement training. However, I found no evidence that the Command, although aware of this deficiency, ever requested specific corrections training from the Commandant of the Military Police School, the US Army Confinement Facility at Mannheim, Germany, the Provost Marshal General of the Army, or the US Army Disciplinary Barracks at Fort Leavenworth, Kansas. (ANNEXES 19 and 76) 5. (U) I

find that without adequate training for a civilian internee detention mission, Brigade personnel relied heavily on individuals within the Brigade who had civilian corrections experience, including many who worked as prison guards or corrections officials in their civilian jobs. Almost every witness we interviewed had no familiarity with the provisions of AR 190-8 or FM 3-19.40. It does not appear that a Mission Essential Task List (METL) based on in-theater missions was ever developed nor was a training plan implemented throughout the Brigade. (ANNEXES 21, 22, 67, and 81) 6. (U) I also find, as did MG Ryder's Team, that the 800th MP Brigade as a whole, was understrength for the mission for which it was tasked. Army Doctrine dictates that an I/R Brigade can be organized with between 7 and 21 battalions, and that the average battalion size element should be able to handle approximately 4000 detainees at a time. This investigation indicates that BG Karpinski and her staff did a poor job allocating resources throughout the Iraq JOA. Abu Ghraib (BCCF) normally housed between 6000 and 7000 detainees, yet it was operated by only one battalion. In contrast, the HVD Facility maintains only about 100 detainees, and is also run by an entire battalion. (ANNEXES 19, 22, and 96) 7. (U) Reserve Component units do not have an individual replacement system to mitigate medical or other losses. Over time, the 800th MP Brigade clearly suffered from personnel shortages through release from active duty (REFRAD) actions, medical evacuation, and demobilization. In addition to being severely undermanned, the quality of life for Soldiers assigned to Abu Ghraib (BCCF) was extremely poor. There was no DFAC, PX, barbershop, or MWR facilities. There were numerous mortar attacks, random rifle and RPG attacks, and a serious threat to Soldiers and detainees in the facility. The prison complex was also severely overcrowded and the Brigade lacked adequate resources and personnel to resolve serious logistical problems. Finally, because of past associations and familiarity of Soldiers within the Brigade, it appears that friendship often took precedence over appropriate leader and subordinate relationships. (ANNEX 101, Multiple Witness Statements, and the Personal Observations of the Investigation Team) 8. (U) With respect to the 800th MP Brigade mission at Abu Ghraib (BCCF), I find that there was clear friction and lack of effective communication between the Commander, 205th MI Brigade, who controlled FOB Abu Ghraib (BCCF) after 19 November 2003, and the Commander, 800th MP Brigade, who controlled detainee operations inside the FOB. There was no clear delineation of responsibility between commands, little coordination at the command level, and no integration of the two functions. Coordination occurred at the lowest possible levels with little oversight by commanders. (ANNEXES 31, 45, and 46)

9. (U) I find that this ambiguous command relationship was exacerbated by a CJTF-7 Fragmentary Order (FRAGO) 1108 issued on 19 November 2003. Paragraph 3.C.8, Assignment of 205th MI Brigade Commander's Responsibilities for the Baghdad Central Confinement Facility, states as follows:

3.C.8. A. (U) 205 MI BRIGADE.

3.C.8. A. 1. (U) EFFECTIVE IMMEDIATELY COMMANDER 205 MI BRIGADE ASSUMES RESPONSIBILITY FOR THE BAGHDAD CONFINEMENT FACILITY (BCCF) AND IS APPOINTED THE FOB COMMANDER. UNITS CURRENTLY AT ABU GHRAIB (BCCF) ARE TACON TO 205 MI BRIGADE FOR "SECURITY OF DETAINEES AND FOB PROTECTION."

Although not supported by BG Karpinski, FRAGO 1108 made all of the MP units at Abu Ghraib TACON to the Commander, 205th MI Brigade. This effectively made an MI Officer, rather than an MP Officer, responsible for the MP units conducting detainee operations at that facility. This is not doctrinally sound due to the different missions and agendas assigned to each of these respective specialties. (ANNEX 31)

10 (U) Joint Publication 0-2, Unified Action Armed Forces (UNAAF), 10 July 2001 defines Tactical Control (TACON) as the detailed direction and control of movements or maneuvers within the operational area necessary to accomplish assigned missions or tasks. (ANNEX 42)

"TACON is the command authority over assigned or attached forces or commands or military capability made available for tasking that is limited to the detailed direction and control of movements or maneuvers within the operational area necessary to accomplish assigned missions or tasks. TACON is inherent in OPCON and may be delegated to and exercised by commanders at any echelon at or below the level of combatant commander."

11. (U) Based on all the facts and circumstances in this investigation, I find that there was little, if any, recognition of this TACON Order by the 800th MP Brigade or the 205th MI Brigade. Further, there was no evidence if the Commander, 205th MI Brigade clearly informed the Commander, 800th MP Brigade, and specifically the Commander, 320th MP Battalion assigned at Abu Ghraib (BCCF), on the specific requirements of this TACON relationship. (ANNEXES 45 and 46)

12. (U) It is clear from a comprehensive review of witness statements and personal interviews that the 320th MP Battalion and 800th MP Brigade continued to function as if they were responsible for the security, health and welfare, and overall security of detainees within Abu Ghraib (BCCF) prison. Both BG Karpinski and COL Pappas clearly

behaved as if this were still the case. (ANNEXES 45 and 46)

Exemptions 3+6 Names withheld  
Normally would not release discussion  
of training requirements however

[REDACTED]  
From: [REDACTED] COL [REDACTED]@us.army.mil] already public record  
Sent: Wednesday, May 12, 2004 5:51 PM  
To: [REDACTED] LTC G3  
Cc: [REDACTED] IMR; [REDACTED] LTC; [REDACTED] MSG; [REDACTED] COL  
Subject: RE: Training for Treatment of Prisoners

Follow Up Flag: Follow up  
Flag Status: Flagged



31E TSP List.ppt

[REDACTED]  
Here is the initial task list we will use in developing the TSP. We probably will add additional tasks but this should give you an idea from where will start. // [REDACTED]

[REDACTED]  
COL, MP  
Director of Training  
United States Army Military Police School  
Ft Leonard Wood, MO 65473  
Comm: (573) 563-[REDACTED]  
DSN: 676-[REDACTED]  
[REDACTED]@od.army.mil

-----Original Message-----

From: [REDACTED] COL - G3-TR [mailto:[REDACTED]@us.army.mil]  
Sent: Wednesday, May 12, 2004 9:08 AM  
To: [REDACTED] COL; [REDACTED] COL - G3-TR  
Cc: [REDACTED] LTC - G3; [REDACTED] - LTC G3; [REDACTED]  
- LTC G3; [REDACTED] SGM; [REDACTED] LTC  
Subject: RE: Training for Treatment of Prisoners

Thanks ... LTCs [REDACTED] cc'd here, are working this action.

-----Original Message-----

From: [REDACTED] COL [mailto:[REDACTED]@us.army.mil]  
Sent: Wednesday, May 12, 2004 9:20 AM  
To: [REDACTED] COL - G3-TR; [REDACTED] COL  
Cc: [REDACTED] LTC - G3; [REDACTED] - LTC G3; [REDACTED] - LTC G3;  
SGM [REDACTED] (E-mail); [REDACTED] LTC [REDACTED] (E-mail)  
Subject: RE: Training for Treatment of Prisoners

[REDACTED] I'm out all day in an EEO inquiry but will give this to one of my guys to work today.  
Will get back to you soonest. // [REDACTED]

[REDACTED]  
COL, MP  
Director of Training  
United States Army Military Police School  
Ft Leonard Wood, MO 65473  
Comm: (573) [REDACTED]

DSN: 676-  
[redacted]@od.army.mil

-----Original Message-----

From: [redacted] COL - G3-TR [mailto:[redacted]@s.army.mil]  
Sent: Wednesday, May 12, 2004 5:10 AM  
To: [redacted] COL  
Cc: [redacted] LTC - G3; [redacted] - LTC G3; [redacted]  
- LTC G3  
Subject: RE: Training for Treatment of Prisoners

[redacted]

Want to publish guidance for specific pre deployment training required for units going over to perform detainee mission ... Previous guidance has stated all units must be proficient in METL derived for mission ... But didn't address each type unit.

Talked w/ MG Barrett yesterday ... He says you all have recommended tasks ... Would appreciate your help here

Also, looking at what training should be required of all soldiers prior to deployment ... Already require Law of Land Warfare and handling of POWs ... Any other tasks you'd recommend?

Thanks,

[redacted]

-----Original Message-----

From: [redacted] COL [mailto:[redacted]@s.army.mil]  
Sent: Tuesday, May 11, 2004 6:19 PM  
To: [redacted]@s.army.mil  
Subject: Training for Treatment of Prisoners

[redacted]

Received instructions from BG Curry to call you ref above. Give me a call or email. [redacted]

[redacted]

COL, MP  
Director of Training  
United States Army Military Police School  
Ft Leonard Wood, MO 65473  
Comm: (573) [redacted]  
DSN: 676-  
[redacted]@od.army.mil



**31E Training Support Package Task List**

- 1. Introduction to Detainee Operations (OIF Detainee Definitions)**
- 2. Communicate with Detainees (Muslim Cultural Awareness)**
- 3. Geneva Conventions (Humane Treatment of Detainees)**
- 4. Stress Management**
- 5. HIV/Universal Precautions within Detainee Operations**
- 6. Use of Force for Detainee and Interrogation Operations DROE/IROE)**
- 7. Detainee Frisk, Undress, Cell and Area Search Procedures**
- 8. Restraint Procedures for Detainees**
- 9. Personal Safety Awareness**
- 10. React to a Physical Attack using Unarmed Self Defense Techniques**
- 11. Forced Cell Move (FCM) Procedures**
- 12. Respond to a Bomb Threat and/or a Bomb within Detainee Operations**
- 13. Emergency Actions for Fire, Escapes and Disorders within Detainee Facilities**
- 14. Cell Block Operations within a Detainee Camp**
- 15. Accountability Procedures**
- 16. Perform Security and Control Activities within Detainee Operations**
- 17. Special Housing Unit (SHU) / Segregation Operations**
- 18. Main Gate/Sally Port Operations**
- 19. Visitation Procedures**
- 20. Escort Procedures within Detainee Operations**
- 21. Meal Operations within a Detainee Camp**
- 22. Non-Lethal Weapons Capabilities during Disorders/Disturbances within Detainee Operations**

Exemption 3+6: names with  
Ex 5 (deliberative)

[REDACTED]  
From: [REDACTED] COL  
Sent: Saturday, May 15, 2004 12:20 PM  
To: FORSCOM DCSOPS TNG CAT; [REDACTED] CFLCC/3A-FWD-C3  
Cc: Colglazier, Dan M. BG - (DIRMOBFOR)  
Subject: FW: TRAINING FOR TREATMENT OF PRISONERS  
Follow Up Flag: Follow up  
Flag Status: Flagged

[REDACTED] let me see tasks / detainee ops tng guidance msg on Mon

COL (P) [REDACTED] Law of War and Hague/Geneva Convention tasks are included in the new OIF tng guidance for all deploying soldiers

per below, has cficc accepted responsibility to train all other tasks related to detainee ops for units so missioned? 2 days is a luxury we don't have with most units ... will review LTG McKiernan's white paper, then shoot you our proposed guidance for chop. Thanks,

EX 5

[REDACTED]

-----Original Message-----

**From:** Curry, Stephen J BG LEONARD WOOD [mailto:stephen.curry@monroe.army.smil.mil]  
**Sent:** Friday, May 14, 2004 6:14 PM  
**To:** Barrett, Raymond D Jr MG TRADOC DCSOPS&T; 'Taguba, Antonio MG CFLCC/3A-ATL-CMD GRP'  
**Cc:** Burns, Jr. Julian H. MG TCOS/G3/G5/G7; 'Louis W. BG ARMY G-3/DAMO-TRZ Weber (E-mail)'; Marks, James A MG USAIC&FH; [REDACTED] COL; 'Terry, James COL(P) CFLCC/3A-FWD-C3'; 'CJTF180-DCJS'; 'CJTF180-DCJS'; 'Miller, Thomas G. MG CJTF-7 C3'; [REDACTED] COL; Haub, Larry D. BG - (DIRMOBFOR); 'Louis W. BG ARMY G-3/DAMO-TRZ Weber (E-mail)'; Ryder MG Don (E-mail); [REDACTED]iraq.centcom.smil.mil'  
**Subject:** RE: TRAINING FOR TREATMENT OF PRISONERS

Sirs

The MP School is currently supporting detention operations training at Fort Dix for units slated to deploy to GTMO to perform the detention mission. I visited this training last week and can attest to the fact that it meets the Army standards.

In addition, there are 26 MOS 31E (Corrections) NCOs deployed to Iraq conducting detention ops training for both MP and non-MP units who are or will be performing the detention mission. They are using a TSP developed by our corrections SME at USAMPS who has conducted three visits to GTMO and two to Iraq in the past year. To date 713 of 1458 Soldiers, airman and marines have been trained. End of training is projected for 24 June 2004.

In both training programs, the instruction makes no distinction based on the technical legalities of the prisoners' Geneva Convention status. In both programs, the requirement for humane treatment of all prisoners at all times as specified under the Geneva Conventions is repeatedly and strongly reinforced.

V/R  
[REDACTED]

BG Steve Curry  
Commandant  
US Army Military Police School  
401 MANSCEN Loop, Suite 1061  
Fort Leonard Wood, MO 65473  
DSN 676 [REDACTED]/COMM (573)563 [REDACTED]  
STE 676 [REDACTED]/COMM (573)563 [REDACTED]  
currysj@monroe.army.smil.mil

-----Original Message-----

**From:** Barrett, Raymond D Jr MG TRADOC DCSOPS&T  
**Sent:** Friday, May 14, 2004 3:53 PM  
**To:** 'Taguba, Antonio MG CFLCC/3A-ATL-CMD GRP'  
**Cc:** Burns, Jr. Julian H. MG TCOS/G3/G5/G7; 'Louis W. BG ARMY G-3/DAMO-TRZ Weber (E-mail)'; Marks, James A MG USAIC&FH; Curry, Stephen J BG LEONARD WOOD; [REDACTED] COL; [REDACTED] COL(P) CFLCC/3A-FWD-C3; CJTF180-DCJS; CJTF180-DCJS; Miller, Thomas G. MG CJTF-7 C3; Maher, Christopher M. - COL; Haub, Larry D. BG - (DIRMOBFOR); 'Louis W. BG ARMY G-3/DAMO-TRZ Weber (E-mail)'  
**Subject:** RE: TRAINING FOR TREATMENT OF PRISONERS

Tony -

I'll check. I'm reasonably sure we have made that distinction in training between GITMO and IZ, but will make sure [redacted] has worked the trap lines. Thanks.

-----Original Message-----

**From:** Taguba, Antonio MG CFLCC/3A-ATL-CMD GRP  
[mailto:Antonio.Taguba@arcent.army.smil.mil]

**Sent:** Thursday, May 13, 2004 3:20 PM

**To:** Burns, Jr. Julian H. MG DCS G-3/5/7; Barrett, Raymond D Jr MG; Burns, Jr. Julian H. MG DCS G-3/5/7

**Cc:** 'Louis W. BG ARMY G-3/DAMO-TRZ Weber (E-mail)'; Marks, James A MG; Curry, Stephen J BG; Turner, Frank D. - COL; Taguba, Antonio MG CFLCC/3A-ATL-CMD GRP; Terry, James COL(P) CFLCC/3A-FWD-C3; CJTF180-DCJS; CJTF180-DCJS; Miller, Thomas G. MG CJTF-7 C3; [redacted] COL; Colglazier, Dan M. BG - (DIRMOBFOR); 'Louis W. BG ARMY G-3/DAMO-TRZ Weber (E-mail)'

**Subject:** RE: TRAINING FOR TREATMENT OF PRISONERS

JB, Ray...to add...

There is a major concern on treatment of detainees at GITMO vice in IZ. In particular, the application of the Geneva Convention to those detained at GITMO since they are categorized as members of terrorists organization, are stateless, and whereby the GC is not applicable. There is specific language in executive order that enumerates this. Members of Congress have questioned this during hearings this week.

*Ex 5  
delib  
process*

[Large redacted block of text]

Tony

-----Original Message-----

**From:** Burns, Jr. Julian H. MG DCS G-3/5/7

**To:** Barrett, Raymond D Jr MG; Burns, Jr. Julian H. MG DCS G-3/5/7

**Cc:** Louis W. BG ARMY G-3/DAMO-TRZ Weber (E-mail); Marks, James A MG; Curry, Stephen J BG; [redacted] COL; Taguba, Antonio MG CFLCC/3A-ATL-CMD GRP; Terry, James COL(P) CFLCC/3A-FWD-C3; CJTF180-DCJS; CJTF180-DCJS; Miller, Thomas G. MG CJTF-7 C3; [redacted] COL; Colglazier, Dan M. BG - (DIRMOBFOR); Louis W. BG ARMY G-3/DAMO-TRZ Weber (E-mail)

**Sent:** 5/10/2004 9:02 PM

**Subject:** RE: TRAINING FOR TREATMENT OF PRISONERS

thats the ticket

tx

and we need packages to give our conusa and our ac cdrs to improve what

training we presently provide to mp's and to the force in general

the sooner the better for our forces are moving now to oif 2.5 and oif 3

burns

-----Original Message-----

From: Barrett, Raymond D Jr MG TRADOC DCSOPS&T

[mailto:raymond.barrett@monroe.army.smil.mil]

Sent: Monday, May 10, 2004 9:50 PM

To: Burns, Jr. Julian H. MG TCOS/G3/G5/G7

Cc: Louis W. BG ARMY G-3/DAMO-TRZ Weber (E-mail); Marks, James A MG

USAIC&FH; Curry, Stephen J BG LEONARD WOOD [REDACTED] COL;

Taguba, Antonio MG CFLCC/3A-ATL-CMD GRP; Terry, James COL(P)

CFLCC/3A-FWD-C3; CJTF180-DCJS; CJTF180-DCJS; Miller, Thomas G. MG CJTF-7

C3 [REDACTED] COL; Haub, Larry D. BG - (DIRMOBFOR)

Subject: RE: TRAINING FOR TREATMENT OF PRISONERS

JB -

We can/will. Currently MI and MP schools are conducting scrub of doctrine. Interim MP doctrine is being prepared incorporating lessons learned from GTMO incidents that fits current issue. Simultaneous effort getting generated is review of what we are teaching in our schools concerning handling/treatment of EPOW and interned Civilians. Center of gravity will be at MP school. I'll have my guys contact [REDACTED]

Steve -

Have your DOT call COL [REDACTED] at FORSCOM G3 to affect direct liaison. Please keep [REDACTED] in the loop.

Barrett

-----Original Message-----

From: Burns, Jr. Julian H. MG DCS G-3/5/7

[mailto:laopsjhb@forcel.army.smil.mil]

Sent: Friday, May 07, 2004 8:33 AM

To: [REDACTED] COL

Cc: Louis W. BG ARMY G-3/DAMO-TRZ Weber (E-mail); Taguba, Antonio MG

CFLCC/3A-ATL-CMD GRP; Terry, James COL(P) CFLCC/3A-FWD-C3; CJTF180-DCJS;

CJTF180-DCJS; Miller, Thomas G. MG CJTF-7 C3; [REDACTED]

COL; Colglazier, Dan M. BG - (DIRMOBFOR); Barrett, Raymond D Jr MG

Subject: TRAINING FOR TREATMENT OF PRISONERS

[REDACTED]

IT OCCURS THAT WE DO NOT HAVE TIME TO WAIT FOR EXTENDED STUDIES, AND

NEED TO ASSURE NEEDED FIXES ARE APPLIED NOW TO DEPLOYING TRAINING

A QUICK LOOK NOW FOLLOWED BY MORE RIGOROUS REVIEW IN DUE TIME IS INDICATED

PLS COORDINATE WITH DAMO TR AND TRADOC TO SEE IF WE HIT ALL THE BASES

FIRST POINT OF FOCUS IS TRAINING GUIDANCE FOR FORCES DEPLOYING IN THE NEXT 60 DAYS....INTERALIA, OIF 2.5

LETS HAVE A DRAFT COORDINATED WITH DA, CFLCC, AND CONUSA AND TRADOC BY THURSDAY NEXT WEEK

BURNS

RAY BARRETT...CAN YALL ASSIST...WANT TO GIVE OUR CONUSA OUR BEST SHOT ON THE FIRST GO

Exemption 3t 6 - names withheld  
The attached training information  
Normally would not release however  
most already publically  
released

[Redacted]

From: [Redacted] - MAJ G3  
Sent: Tuesday, February 03, 2004 1:18 PM  
To: [Redacted] - G3  
Subject: FW: VCSA Tasker - Detainee Abuse

Follow Up Flag: Follow up  
Flag Status: Flagged



FT CARSON MP, TASK CONDUCT TASK PERFORM 220 mp ENCL 1.doc 220 MP validation 220MP brief.ppt Validation  
EWP FOR OIF.pdf) LLECTING PT ANELD PROCESSING memo.doc recommendation.do

MAJ [Redacted]  
G3 Training  
DSN 367- [Redacted] Comm 404- [Redacted]

-----Original Message-----

From: 5AEOCTNG [mailto:5AEOCTNG@fifth.army.mil]  
Sent: Tuesday, February 03, 2004 1:12 PM  
To: [Redacted] - MAJ G3  
Cc: 5AEOCTNG; 5AEOC  
Subject: FW: VCSA Tasker - Detainee Abuse

> MAJ [Redacted]  
> We have queried our divisions and the best information from OIF 1 is  
> below.  
> 2/91:

> > <<FT CARSON MP, EWP FOR OIF.pdf>> > > <<TASK CONDUCT COLLECTING PT  
> > AND HOLDING AREA OPS.pdf>> > > <<TASK PERFORM FIELD PROCESSING OF  
> > ENEMY PRISONERS OF WAR.pdf>> > > <<220 mp ENCL 1.doc>> > > <<220  
> > MP validation memo.doc>> > > <<220MP brief.ppt>>  
>  
>  
> 2/75  
> <<Validation Recommendation.doc>>

> MAJ [Redacted]  
> Fifth Army EOC G3-Training Desk Officer  
> DSN: 471- [Redacted] Commercial (210) 221- [Redacted]  
>





ELEMENTS: MP Platoon/Squad  
Platoon HQ

TASK: Conduct Collecting Point and Holding Area Operations (19-3-31003)  
(FM 19-4)



ITERATION: 1 2 3 4 5 M (Circle)

COMMANDER/LEADER ASSESSMENT: T P U (Circle)

CONDITIONS: An MP platoon has been tasked to establish and operate a collecting point or holding area. Some iterations of this task should be performed in MOPP4.

TASK STANDARDS: The platoon establishes a central collecting point or a holding area. It correctly processes EPW/CIs, dislocated civilians, and/or US military prisoners. It also maintains complete accountability of all personnel.

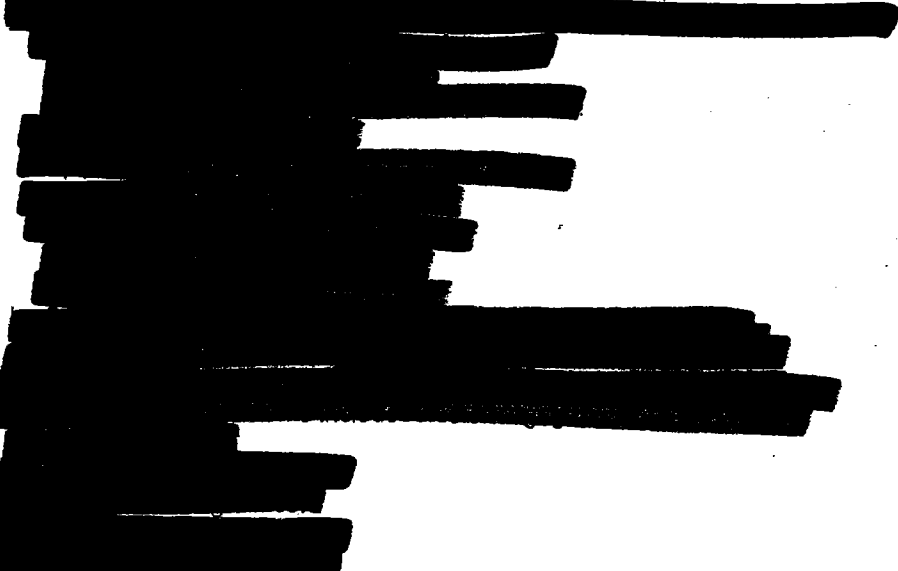
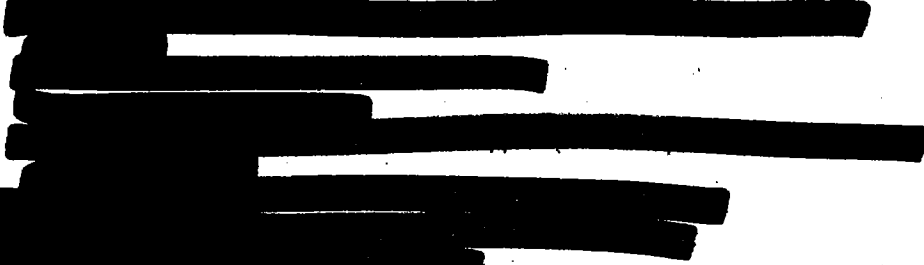
B2 HIGH

TASK STEPS AND PERFORMANCE MEASURES	GO	NO-GO
* 1. Platoon leader initiates troop-leading procedures upon receipt of mission. 		
* 2. Platoon sergeant coordinates support requirements. 		
3. Platoon prepares for the construction of the collecting point or holding area. 		



B2  
HIGH

TASK STEPS AND PERFORMANCE MEASURES	GO	NO-GO
[REDACTED]		
6. Squads/teams guard the collecting point or holding area. [REDACTED]		
* 7. Platoon leader updates higher headquarters on status of the mission. [REDACTED]		

TASK PERFORMANCE / EVALUATION SUMMARY BLOCK							
ITERATION	1	2	3	4	5	M	TOTAL
TOTAL TASK STEPS EVALUATED							
TOTAL TASK STEPS "GO"							
TRAINING STATUS "GO"/"NO-GO"							

\*\*\* indicates a leader task step.

**SUPPORTING INDIVIDUAL TASKS**

References	Task Number	Task Title
	191-379-4450	SUPERVISE HANDLING OF ENEMY PERSONNEL AND EQUIPMENT AT UNIT LEVEL
STP 19-95B1-rev-SM	191-376-4108	OPERATE A DISMOUNT POINT
	191-376-5116	PERFORM A STAND-UP SEARCH OR A FRISK (PAT-DOWN)
	191-376-5117	PERFORM A PRONE SEARCH
	191-376-5119	PERFORM A WALL SEARCH
STP 19-95B24-SM-TG	191-377-4205	SUPERVISE PROCESSING OF EPW/CI AT A COLLECTING POINT OR HOLDING AREA
STP 21-24-SMCT	081-831-0101	REQUEST MEDICAL EVACUATION

**ELEMENTS:** MP Platoon/Squad  
Platoon HQ

**TASK:** Perform Field Processing of Enemy Prisoners of War (19-3-31004)  
(FM 19-4)

**ITERATION:** 1 2 3 4 5 (Circle)

**COMMANDER/LEADER ASSESSMENT:** T P U (Circle)

**CONDITIONS:** The platoon must process all enemy soldiers who have surrendered or have been captured within its area of operation. This task should not be trained in MOPP4.

**TASK STANDARDS:** The platoon searches, tags, segregates, silences, speeds, and safeguards each EPW.

B2 HIGH

TASK STEPS AND PERFORMANCE MEASURES	GO	NO-GO
* 1. Platoon leader plans for the processing mission using mission analysis and troop-leading procedures. [REDACTED]		
* 2. Platoon sergeant coordinates for support requirements. [REDACTED]		
3. Platoon members field-process the EPWs. [REDACTED]		

B2 HIGH



TASK STEPS AND PERFORMANCE MEASURES	GO	NO-GO
[REDACTED]		
[REDACTED]		
[REDACTED]		
[REDACTED]		
[REDACTED]		
[REDACTED]		
[REDACTED]		
[REDACTED]		

TASK PERFORMANCE / EVALUATION SUMMARY BLOCK							
ITERATION	1	2	3	4	5		TOTAL
TOTAL TASK STEPS EVALUATED							
TOTAL TASK STEPS "GO"							
TRAINING STATUS "GO"/"NO-GO"							

\*\*\* indicates a leader task step.

**SUPPORTING INDIVIDUAL TASKS**

References	Task Number	Task Title
STP 21-1-SMCT	301-348-1050	REPORT INFORMATION OF POTENTIAL INTELLIGENCE VALUE
STP 21-24-SMCT	081-831-0101 191-379-4450	REQUEST MEDICAL EVACUATION SUPERVISE HANDLING OF ENEMY PERSONNEL AND EQUIPMENT AT UNIT LEVEL

**OPFOR TASKS AND STANDARDS**

NONE:

**220 Military Police Battalion**  
**TECHNICAL/COLLECTIVE TRAINING**

<u>TASK</u>	<u>REF</u>	<u>ASSESSMENT</u>
TCP	19-3-12002	T
TEMP RTE SIGN	19-3-12003	T
RTE R&S	19-3-11002	T
EPW COLLECTING POINT/ HOLDING AREA	19-3-31003	T
OPERATE FIELD DETENTION FACILITY	19-3-32003	T
PREP FOR CHEM ATTACK	3-3-C202	T
RESPONSE FORCE OPS	19-3-22001	T
CONVOY SECURITY	19-3-20004	T
CORDON AND SEARCH	19-3-22006	T
CRITICAL SITE SECURITY	19-3-22004	T
AREA RECON	19-3-20002	T
ZONE RECON	19-3-20003	T
BASE/BASE CLUSTER DEFENSE	19-3-22002	T
CONDUCT INTELLIGENCE OPERATIONS	19-3-52001	T
CROSS CHEM CONTAMINATED AREA	3-3C226	T
FIELD PROCESS EPW'S	19-3-31004	T
TREAT CASUALTIES	8-3-0003	T
TRANSPORT CASUALTIES	8-3-C316	T

001034



## DEPARTMENT OF THE ARMY

3<sup>rd</sup> Battalion, 360<sup>th</sup> Regiment (TS) (CS/CSS)  
108 Soldiers Circle, Fort Douglas  
Salt Lake City, UT 84113-5030

+REPLY TO  
ATTENTION OF:

AFRC-ECA-EB

18 Feb 2003

MEMORANDUM FOR Commander, 2<sup>nd</sup> Brigade, 91<sup>st</sup> Division (TS), Fort Carson, CO 80913

SUBJECT: 220 Military Police Company Post-Mobilization Training Summary.

1. I certify 220 Military Co has completed required post-mobilization training on 18 February 2003 and is prepared to deploy in support of Operation ENDURING FREEDOM.
2. 220 MP Co, Colorado Army National Guard, is a military police unit. The 220 MP Co was alerted for mobilization on 10 January 2003, conducted home station preparations from 13-23 January in Denver, Colorado, and deployed to Fort Carson, CO for post mobilization training from 24 January-18 February 2003.
3. The 220 MP Co successfully conducted 114 of 114 M-16, 120 of 123 M-9, 37 of 37 M-203, 66 of 66 MK-19, and 27 of 27 M249 qualifications, and critical NBC tasks during the post-mobilization training period. The 3 M-9 non qualifications were due to ammunition shortages and will be made up OCONUS.
4. The 220 MP Co is a mission capable unit. Following is a list of trained tasks, strengths, weaknesses, and CDR's Assessment.

<u>TASK</u>	<u>REF</u>	<u>ASSESSMENT</u>
4a. Conduct a TCP	19-3-12002	T
4b. Temp RTE Sign	19-3-12003	P
4c. EPW Collect / Hold	19-3-31003	P
4d. RTE R&S	19-3-11002	T
4e. Operate Field Det FAC	19-3-32003	P
4f. Prep for a Chem Attack	3-3C202	T
4g. Response Force Ops	19-3-22001	P
4h. Convoy Security	19-3-20004	T
4i. Cordon and Search	19-3-22006	P
4j. Critical Site Sec	19-3-22004	P
4k. Area Recon	19-3-20002	T
4l. Zone Recon	19-3-20003	T
4m. Base Cluster Defense	19-3-22002	P
4n. Conduct Intel Ops	19-3-52001	P
4o. Cross chem. Cont area	3-3C226	P
4p. Field Proc EPW	19-3-31004	P

001035

AFRC-ECA-EB-TM VIII  
SUBJECT: Trip Report

4q. Treat Casualties	8-3-0003	P
4r. Transport Casualties	8-3-C316	P

4a, d, h. The 220th is proficient in conducting Traffic Control Points (TCPs), route reconnaissance and surveillance, and convoy security after conducting multiple iterations of these tasks during the collective training phase at mob station. Planning and execution of these missions are this unit's strong points. These tasks are executed well from platoon down to squad level.

4k & l. Each platoon is well versed in conducting Area and Zone Recons. The unit conducts mounted sweeps well and they are exceptionally strong at conducting dismounted sweeps. Overall, control and execution of movement techniques are outstanding.

4m, o. The 220th is capable of conducting the Base / Base cluster defense and the crossing of a chemically contaminated area. Where the unit falls short is the coordination of the unit defense plan (within an overall base cluster defense plan) and unmasking procedures at the platoon and squad levels. Each platoon should take some time to conduct some opportunity training in these tasks. Overall the unit is capable of accomplishing these missions.

5. The 220th MP CO has outlined that the following tasks will occur OCONUS for sustainment training. Platoon and Squad level planning and execution of Cordon and Search procedures, Base / Base Cluster Coordination, and Crossing a Chemically Contaminated Area.

6. Equipment. Currently all unit ERC A shortages are due to FORSCOM shortages. By the unit CDR's assessment only the shortage of 26 of 40 CLS Bags are a concern.

7. Personnel. Unit is required to have 180 PAX and currently has 150 PAX deployable. If the unit drops below 136 PAX they will become P-3.

  
LTC, EN  
Commander, TF ROUGH RIDER





220 MP Company  
POST MOB TRAINING PLAN

- UNIT COMMANDER: [REDACTED]
- TF COMMANDER: [REDACTED]
- OIC/NCOIC: [REDACTED]
- UMA: SFC [REDACTED]



AGENDA

- MISSION
- CONCEPT OF OPERATION
- PLANNING TIMELINE
- TASK ORGANIZATION
- TRAINING CALENDAR
- TASK LIST
- CASEVAC PLAN
- RISK ASSESSMENT
- COMMO PLAN
- LOGISTICS (COST)
- WORKING ISSUES
- QUESTIONS
- GUIDANCE



MISSION

*MISSION STATEMENT...To provide MP combat support to assigned area of operations with special emphasis in Area Support Operations, Maneuver and Mobility Support Operations, Force Protection, and Interment Resettlement Operations.*

*END STATE: Validated and trained in all collective tasks which support the 220<sup>th</sup> Commander's METL.*



CONCEPT OF THE OPERATION

- Company conducted SRP, CIF, mandatory briefings from 27 JAN 03 to 31 JAN 03.
- Company conducted NBC/First Aid from 13 JAN 03 to 19 JAN 03. NBC Chamber conducted 30 JAN 03. 63 pax scheduled for NBC make-up on 18 FEB 03.
- Company conducted M16 qualification on Ranges 51, 55, and 57, 27 JAN 03; M9, M249, M203 and M1200 qualification on Range 5, 28 JAN 03; MK19 qualification on Range 103, 29 and 31 JAN 03. MK19 make-up for 12 pax on 14 FEB 03. M9 (25 pax) and M16 (6 pax) make-up on 15 FEB 03.

### CONCEPT OF THE OPERATION

- Technical training consisting of MP Battle Drills were conducted on 2 Feb 03.
- Collective Task training consisting of Supervise Convoy Security, Direct Response Force Operations, Supervise MP Response to Base/Base Cluster Defense, Supervise Security of a Critical Site, Supervise EPW Holding Area, Prepare for a Chemical Attack/Respond to a Chemical Attack was conducted 3-9 FEB 03.

### TIMELINE

ALERT DATE: 10 JAN 03  
 MOB DATE: 16 JAN 03  
 HOME STATION DATES: 11-23 JAN 03  
 MUC DATE: 17 JAN 03

GBU Training  
 TSD Training  
 Collective Training  
 TSD Training  
 Recovery  
 Deployment

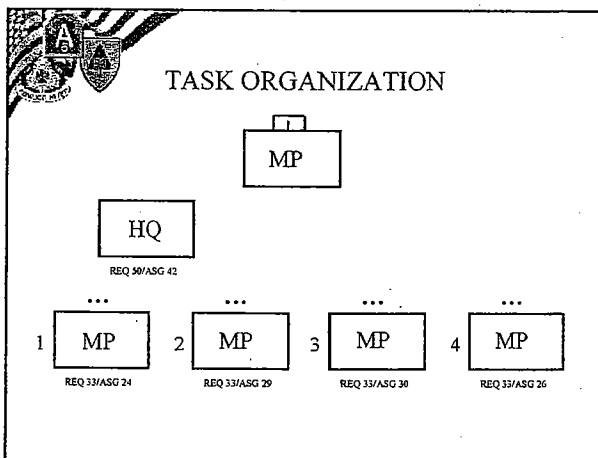

### EVALUATED TASK LIST

INDIVIDUAL TASKS	TASK NUMBER
Protect yourself using your assigned mask	031-503-1035
Maintain your assigned mask	031-503-1036
React to chemical or biological hazard/attack	031-503-1019
Protect yourself with MOPP	031-503-1015
Detect chemical agents using M8 or M9 paper	031-503-1037
Perform first aid to a nerve agent injury	081-831-1044
Decontaminate using decon kits	031-503-1013
Evaluate a casualty	081-831-1000
Prevent shock	081-831-1005
Give first aid for burns	081-831-1007
Perform first aid for cold injuries	081-831-1045
Perform first aid for heat injuries	081-831-1008
Put on a field or pressure dressing	081-831-1016
Put on a tourniquet	081-831-1017
Apply a dressing to an open abdominal wound	081-831-1025
Apply a dressing to an open chest wound	081-831-1026
Apply a dressing to an open head wound	081-831-1033
Splint a suspected fracture	081-831-1034
Perform mouth-to-mouth resuscitation	081-831-1042

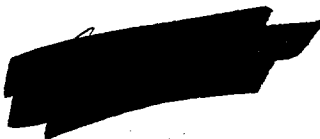

**EVALUATED TASK LIST**

<u>COLLECTIVE TASKS</u>	<u>TASK NUMBER</u>
Supervise Route Reconnaissance and Surveillance	19-2-11002
Supervise Convoy Security	19-2-20004
Direct Response Force Operations	19-2-22001
Supervise MP Response to Base/Base Cluster Defense	19-2-22002
Prepare for Chemical Attack	3-3-C202
Respond to Chemical Attack	3-3-C203
Supervise Security of a Critical Site	19-2-22004
Supervise EPW Holding Area	19-2-31003
Cross a Chemically Contaminated Area	3-3-C226
Secure and Defend Unit Position	07-2-C314
Supervise EPW/CI Collecting, Processing and Evaluation	19-2-31004
Coordinate Intelligence Collecting and Reporting	19-2-32001
Supervise Area Reconnaissance Operations	19-2-20002
Supervise Cordon and Search Operations	19-2-22006
Direct a Delay	19-2-22007
Supervise a Battle Handover to a Tactical Combat Force	19-2-22008

**EVALUATED TASK LIST**

<u>TECHNICAL TASKS</u>	<u>TASK NUMBER</u>
Traveling Overwatch	ARTEP 19-100-10-DRILL
Bounding Overwatch	ARTEP 19-100-10-DRILL
React to Indirect Fire	ARTEP 19-100-10-DRILL
React to an Ambush	ARTEP 19-100-10-DRILL
Dismount and Place MK19 into Action	ARTEP 19-100-10-DRILL
Assemble and Erect OOE-254/GRC Antenna System	ARTEP 19-100-10-DRILL
Movement and Mobility Support Actions	ARTEP 19-3-313-30
Area Security Operations	ARTEP 19-3-313-30
Police Intelligence Operations	ARTEP 19-3-313-30
Law and Order Operations	ARTEP 19-3-313-30
Internment Resettlement Operations	ARTEP 19-3-313-30

**RESOURCES**

<u>RESOURCE</u>	<u>SOURCE</u>	<u>COORD</u>	<u>O/H</u>
OPFOR		AR BN	13
Motorola	BDE	LSBn	6
Heaters	TF RR	S-4	10
NVGs	BDE	LSBn	16

- CASEVAC PLAN**
- REAL WORLD EMERGENCY
- Call Range Control at (719) 526-2292/5698
  - Primary Frequency 38.80 MHz
  - Alternate Frequency 39.60 MHz
  - Provide the following information after person has been evacuated:
    - Name(s) of injured person(s)
    - Rank
    - Social Security Number
    - Weapons and ammunition data, if involved
- TRAINING CASUALTY EVAC
- IAW UNIT SOP
  - O/C/T WILL ASSESS CASUALTY IAW ROE

## RISK MANAGEMENT

A. Mission or Task 320th MP PTR		B. Risk/Threat Group Major: UHFHF, FEB 2003 Subj: UHFHF, FEB 2003			
C. Principal Mgr. (Name, Location, Org/Position) CPT Bas Meier, Chet A., Senior MP CCIT					
D. Task	E. Priority/Risk	F. Resource	G. Action	H. Control/Contingency	I. Outcome
Identify and report	Identify and report	Identify and report	Identify and report	Identify and report	Identify and report
Identify and report	Identify and report	Identify and report	Identify and report	Identify and report	Identify and report
Identify and report	Identify and report	Identify and report	Identify and report	Identify and report	Identify and report

## COMMUNICATIONS PLAN

- PRIMARY
  - UHF HANDHELD
  
- SECONDARY
  - Land Line and Cell Phone

## LANE CONCEPT

### TRAINING SCENARIO

- KUWAIT THEATER OF OPERATIONS
  - SEPARATE COMPANY UNDER NOTIONAL 320TH MP BDE
  - OPERATING OUT OF BASE RED DEVIL
  - CONDUCT FULL SPECTRUM OF MP MISSIONS (MMSO, ASO, IRO, L&O, PIO)
- CONTINUOUS 24-HOUR OPERATIONS
  - CDR ESTABLISHES ROUTINE TO FACILITATE 24-HOUR COVERAGE
  - FRAGO TEMPO CONTROLS OPTEMPO

## LANE CONCEPT

### TRAINING SCENARIO

- EXERCISE ENTIRE COMPANY
  - C2 AND OPERATIONS
  - FOUR LINE PLATOONS
  - SUPPLY
  - FOOD SERVICE
  - PAC
  - MAINTENANCE
  - MEDICAL

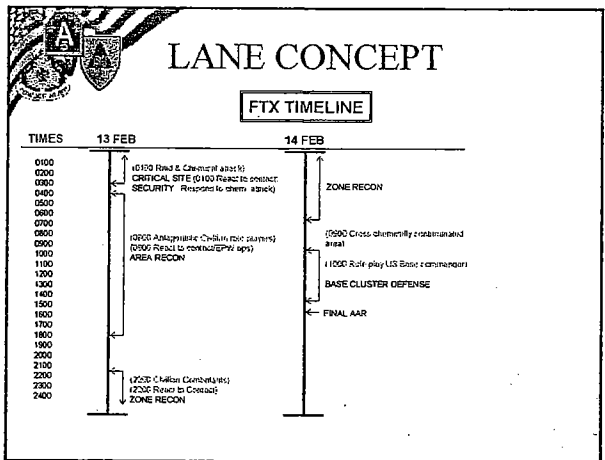
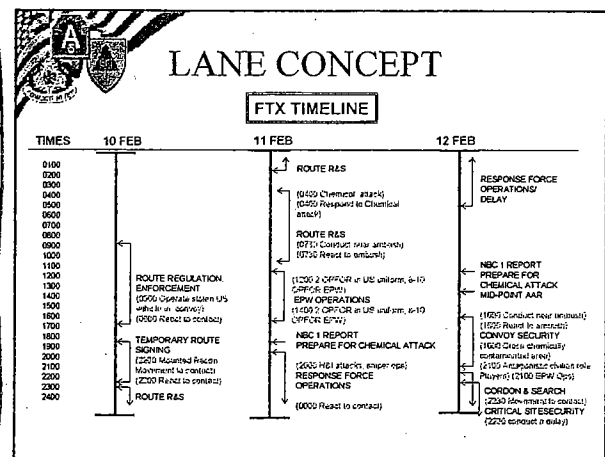
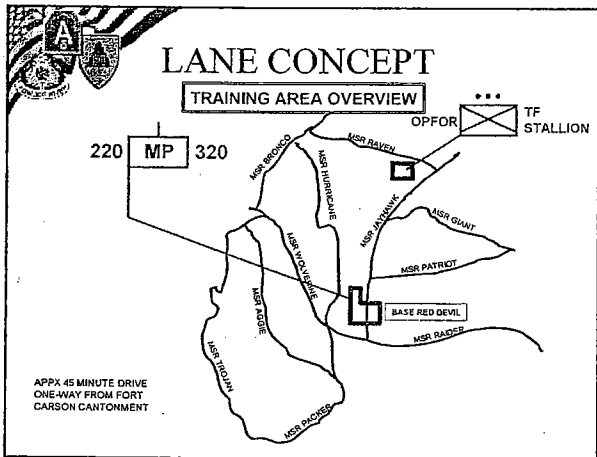



### WORKING ISSUES

- Completion of weapons qualifications and shots.



LESSONS LEARNED

- Communications: Need SINGARS and OE-254 radio antenna's for retrans
- Better communication with OPFOR

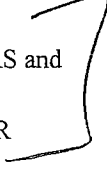

COMMANDER'S  
GUIDANCE

DEPARTMENT OF THE ARMY  
HEADQUARTERS, 2<sup>ND</sup> BN, 290<sup>TH</sup> REGT, 4<sup>TH</sup> BDE, 75<sup>TH</sup> DIV (EX)  
2101 NORTHEAST 36<sup>TH</sup> STREET  
OKLAHOMA CITY, OK 73111-0000

AFRC-TTC-4B-2/290

22 February 2003

MEMORANDUM THRU

Mobilization Assistance Team, 56408, Fort Hood, TX, 76544-5000

Mobilization Unit In-Processing Center (MUIC), Bldg. 3506, Ft. Hood TX 76544-5000

FOR COMMANDER, Fort Hood, Garrison, 1234 Street, BLDG 1123  
Fort Hood, Texas 76544

SUBJECT: 302<sup>nd</sup> Military Police Company (WVJ5AA) Validation

1. PURPOSE: To provide validation assessment on the mobilization status and training proficiency of the 302<sup>nd</sup> Military Police Company in support of Operation Enduring Freedom.
2. GENERAL: Over the FY 2002, the 302<sup>nd</sup> Military Police Company executed their Annual Training at Ft. Irwin, California and the National Training Center. They provided Military Police Support to the combatant commander for the mission. The unit established company operations and dispersed the platoons into platoons areas of responsibility. The company executed military missions across a broad spectrum of MP doctrinal support missions. The unit executed all of their METL tasks during this exercise. During the present FY, the unit has executed an externally evaluated Military Police Stakes that included over 20 military police individual, team and squad level tasks.
3. The 302<sup>nd</sup> Military Police Company has executed the following training:
  - A. The 302<sup>nd</sup> Military Police Company conducted In-Processing and Activation operations from 14 January to 24 January 2003. This process included the following:
    - a. Legal
    - b. Finance
    - c. Medical
    - d. Dental
    - e. Shots
    - f. Identification Tags and Card
    - g. Personal Records
  - B. The 302<sup>nd</sup> Military Police Company conducted Common Task Training and Testing from 20 January 2003 to 03 February 2003. This training and testing included:

001043

- a. Protect yourself from Chemical/Biological Contamination using your assigned Protective Mask (031-503-1035)
- b. Maintain your assigned Protective Mask (031-503-1036)
- c. React to a Chemical or Biological Hazard / Attack (031-503-1019)
- d. Protect yourself from NBC Injury/Contamination with MOPP Gear (031-503-1015)
- e. Identify Chemical Agents using M8 Detector Paper (031-503-1014)
- f. Protect yourself from NBC Injury/Contamination when Drinking from your Canteen While wearing your Protective Mask (031-503-1006)
- g. Administer First Aid to a Nerve Agent Casualty (Buddy Aid) (081-831-1030)
- h. Administer Nerve Agent Antidote to Self (Self Aid) (081-831-1031)
- i. Decontaminate Yourself and Individual Equipment using Chemical Decontamination Kits (031-503-1013)
- k. Prevent Shock (081-831-1005)
- l. Give First Aid For Burns (081-831-1007)
- m. Perform First Aid for Heat Injuries (081-831-1008)
- n. Put on a Tourniquet (081-831-1017)
- o. Apply a dressing to an Abdominal Wound (081-831-1025)
- p. Apply a dressing to an Open Chest Wound (081-831-1026)
- q. Apply a dressing to an Open Head Wound (081-831-1033)
- r. Splint a Suspected Fracture (081-831-1034)
- s. Evaluate a Casualty (081-831-1000)
- t. Put on a Field or Pressure Dressing (081-831-1016)
- u. Prevent Heat Injury
- v. Prevent Cold Weather Injury

C. The 302<sup>nd</sup> Military Police Company conducted Force Protection Training and Evaluation from 03 to 13 February 2003. This training and evaluation included:

- a. Conduct a Defense (07-2-1045)
- b. Employ and Obstacle (07-2-1369)
- c. Take Action on Contact (07-2-1468)
- d. Establish Observation Post (07-2-2027)
- e. Report Tactical Information (07-2-2070)
- f. Conduct Overwatch and or Support by Fire (07-2-3000)
- g. Conduct Troop Leading Procedures (07-2-5081)
- h. Prepare for a Chemical Attack (07-2-6117)
- i. React to a Chemical Attack (07-2-6117)
- j. Conduct a Security Patrol (07-3-1153)
- k. Take Action on Contact (07-3-1432)
- l. Conduct Response Force Operations (19-3-22001)
- m. React to a Sniper
- n. React to Indirect Fire

D. The 302<sup>nd</sup> Military Police Company conducted Combat Support and Combat Service Support and Logistical training from 14 January 2003 to 20 February 2003. The training included:

001044



- a. Conduct Class I Support Operations
- b. Conduct Class III Support Operations
- c. Conduct Class V Support Operations
- d. ULLS S-4
- e. ULLS G
- f. Maintain Unit Logistics
- g. Request, Receive and Turn-in Supplies
- h. Inventory Procedures
- i. Sensitive Items Inventory
- j. Accountability of Class VIII Supplies

E. The 302<sup>nd</sup> Military Police Company conducted individual and crew serve weapons preliminary marksmanship instruction and qualification on the following weapons:

- a. PMI and Qualification: M9 Pistol
- b. PMI and Qualification: M16A2 Rifle
- c. PMI and Qualification: M203 Grenade Launcher
- d. PMI and Qualification: M249 Machine Gun
- e. PMI and Qualification: MK 19 Grenade Machine Gun

F. The 302<sup>nd</sup> Military Police Company conducted Individual Required Training (IRT) on the following tasks:

- a. Use of Force (ROE/RUF)
- b. Force Protection
- c. Threat Assessment
- d. HAZMAT
- e. In Country Brief
- f. SAEDA
- g. Biological Protection Brief
- h. Media Awareness Brief
- i. Law of War

G. The 302<sup>nd</sup> Military Police Company conducted TOC and Headquarters Platoon Training from 14 January to 17 February 2003. The following tasks were trained:

- a. Battle Tracking
- b. NBC Tracking and Reporting
- c. Operating a Secure Net
- d. Compiling and reporting Tactical Information
- e. Prepare and Update and Overlay
- f. Mission Analysis / Mission Allocation
- g. Coordination with Rear Area Operations Center

H. The 302<sup>nd</sup> Military Police Company conducted collective training from 01 to 20 February 2003. The following tasks with their associated subtasks were trained and evaluated:

001045

- a. Conduct Deployment Operations
- b. Conduct Area / Zone Reconnaissance
- c. Conduct Response Force Operations
- d. Conduct Security of a Critical Site
- e. Conduct Convoy Security
- f. Conduct Route Reconnaissance and Surveillance
- g. Establish an EPW Holding Area
- h. Conduct Law Enforcement Operations
- i. Prepare for and React to an NBC Attack

4. CURRENT ASSESSMENT: Unit has completed mandated / suggested training in order to meet mission requirements. Unit is prepared to deploy and achieve mission success in their current theater of assignment in accordance with the assigned mission.

5. Questions and concerns can be directed to the undersigned at (405) 426- [REDACTED] or [REDACTED]@usarc-emh2.army.mil.

Enclosures  
CENTCOM TSR  
Training Tracking Sheets  
Training Sign-In Sheets  
Weapons Qualifications

[REDACTED]  
CPT, MP  
475 Unit Assistor

001046

1000



2BCT DETAINEE AND EPW  
TRAINING PACKAGE



AGENDA

- I. DEFINITION OF A DETAINEE & EPW
- II. GENERAL OVERVIEW OF GENEVA CONVENTION WITH RESPECT TO PRISONERS OF WAR
- III. COMMAND POLICIES ON TREATMENT AND QUESTIONING OF DETAINEES
- IV. RULES OF ENGAGEMENT FOR DETENTION FACILITIES
- V. TRAINING VIGNETTES



2BCT DETAINEE AND EPW  
TRAINING PACKAGE



AGENDA

- I. DEFINITION OF A DETAINEE & EPW
- II. GENERAL OVERVIEW OF GENEVA CONVENTION WITH RESPECT TO PRISONERS OF WAR
- III. COMMAND POLICIES ON TREATMENT AND QUESTIONING OF DETAINEES
- IV. RULES OF ENGAGEMENT FOR DETENTION FACILITIES
- V. TRAINING VIGNETTES



DEFINITIONS



DETAINEE VS. EPW

- > ALL PERSONS UNDER THE CONTROL OF U.S. FORCES ARE CONSIDERED DETAINEES.
- > AT THE POINT OF CAPTURE IT IS TOO DIFFICULT TO DETERMINE WHETHER A PERSON IS AN EPW, SECURITY INTERNEE, CIVILIAN, CRIMINAL DETAINEE, ETC.
- > TO AVOID CONFUSION AND LEGAL IMPLICATIONS OF ARBITARILY CLASSIFYING INDIVIDUALS, WE REFER TO THEM AS DETAINEES AND TREAT THEM AS EPWS.



2BCT DETAINEE AND EPW  
TRAINING PACKAGE



AGENDA

- I. DEFINITION OF A DETAINEE & EPW
- II. GENERAL OVERVIEW OF GENEVA CONVENTION WITH RESPECT TO PRISONERS OF WAR
- III. COMMAND POLICIES ON TREATMENT AND QUESTIONING OF DETAINEES
- IV. RULES OF ENGAGEMENT FOR DETENTION FACILITIES
- V. TRAINING VIGNETTES



## GENEVA CONVENTIONS- BASIC RULES



- THE GENEVA CONVENTIONS REQUIRE PROPER TREATMENT OF ALL DETAINEES:

ALL DETAINEES ARE TREATED AS PRISONERS OF WAR. PRISONERS OF WAR HAVE SPECIFIC PROTECTIONS DESIGNED TO PROTECT UNNECESSARY SUFFERING AND TO PROTECT OUR OWN SOLDIERS IN THE EVENT OF CAPTURE.

- Humane Treatment
- No Medical Experiments
- Protect EPWs from Violence, Intimidations and Public Curiosity
- Equality of Treatment
- Provide Medical Care
- Respect for Persons with Special Needs (disabled, elderly, women and children)
- No humiliation or reprisal (pictures only for intelligence purposes)



## GENEVA CONVENTIONS- BASIC RULES



- WHAT ARE THE GENEVA CONVENTIONS?
- HOW DO THEY RELATE TO THE LAW OF WAR (LAW OF ARMED CONFLICT)?
- HOW DOES GPW RELATE TO THE CODE OF CONDUCT?
- WHY DO WE COMPLY WITH THESE RULES?

Protects our soldiers

Encourages the enemy to surrender

Prevents enemy propaganda exploitation



## GENEVA CONVENTIONS- BASIC RULES



- SPECIFIC RESTRICTIONS:

### INTERROGATION, CAMP DISCIPLINE AND CAMP LABOR:

THTs can ask EPWs anything, so long as no torture, threats or coercion is used.

EPWs are only required to provide their first and last name, their rank, date of birth and their service number (SSN).

1AD Policy prohibits the use of EPWs to perform labor, except to conduct police calls of their own AO.

Camp Discipline for breaches of Camp Policy is limited to isolation or reasonable control measures to maintain order.

BOTTOM LINE: BCT AND BN HOLDING AREAS ARE TEMPORARY AND ARE DESIGNED TO CARE FOR EPWS AND TO OBTAIN INFORMATION FOR A SHORT TIME UNTIL THEY ARE TRANSFERRED TO A PERMANENT FACILITY OR UNTIL THEY ARE RELEASED.



## 2BCT DETAINEE AND EPW TRAINING PACKAGE



### AGENDA

- I. DEFINITION OF A DETAINEE & EPW
- II. GENERAL OVERVIEW OF GENEVA CONVENTION WITH RESPECT TO PRISONERS OF WAR
- III. COMMAND POLICIES ON TREATMENT AND QUESTIONING OF DETAINEES
- IV. RULES OF ENGAGEMENT FOR DETENTION FACILITIES
- V. TRAINING VIGNETTES



### TREATMENT OF DETAINEES- ADDITIONAL GUIDANCE



- > IN ADDITION TO THE 2BCT COMMANDER'S INTERROGATION POLICY THE FOLLOWING SPECIFIC GUIDANCE IS EMPHASIZED:
  - ANY INTERROGATION TECHNIQUES CONSIDERED ABUSIVE IN ANY WAY ARE NOT AUTHORIZED, THIS INCLUDES SLEEP DEPRIVATION AND STRESS POSITIONS. DO NOT HAVE DETAINEES STAND ON SANDBAGS. DO NOT MAKE DETAINEES STAY AWAKE AS A CI TACTIC. DO NOT FORCE DETAINEES TO DO PT. 1AD FRAGO 72A.
  - A VIOLATION OF THE GENEVA CONVENTIONS CAN HAVE INTERNATIONAL RAMIFICATIONS:
    - NOT ONLY YOU, BUT THE UNITED STATES CAN BE HELD ACCOUNTABLE FOR GRAVE BREACHES OF THE PROTECTIONS AFFORDED TO EPWS. FOR LESSER CRIMES, THERE ARE A VARIETY OF LAWS AND POLICIES THAT MAY GOVERN.



### REMINDER ON TREATMENT OF DETAINEES



- > 1AD GENERAL ORDER: FRAGO 383A/98A
    - THE MALTREATMENT OR ABUSE OF ANY IRAQI CIVILIAN OR DETAINEE IS PROHIBITED BY THE 1AD COMMANDER. A VIOLATION OF THIS ORDER IS PUNISHABLE UNDER ARTICLE 92 OF THE UCMJ. ASSAULT OF A DETAINEE IS ALSO PUNISHABLE UNDER ARTICLE 128.
    - THE UCMJ ALSO PROHIBITS THE DESTRUCTION OR FAILURE TO TURN-IN CAPTURED PROPERTY OF THE ENEMY OR DETAINEES:
      - ARTICLE 103 PROHIBITS THE WRONGFUL DISPOSAL, SALE OR USE OF CAPTURED PROPERTY AS WELL LOOTING OR PILLAGING. THE MAXIMUM PUNISHMENT UNDER THIS ARTICLE IS LIFE IMPRISONMENT.
- NOTE: General Order #1 A also prohibits looting, pillaging or the taking of enemy or civilian property without express authorization of a Commander and only for military necessity.



### 2BCT DETAINEE AND EPW TRAINING PACKAGE



#### AGENDA



- I. DEFINITION OF A DETAINEE & EPW
- II. GENERAL OVERVIEW OF GENEVA CONVENTION WITH RESPECT TO PRISONERS OF WAR
- III. COMMAND POLICIES ON TREATMENT AND QUESTIONING OF DETAINEES
- IV. RULES OF ENGAGEMENT FOR DETENTION FACILITIES
- V. TRAINING VIGNETTES



### DETENTION FACILITY ROE





- THE FOLLOWING RULES OF ENGAGEMENT APPLIES TO RIOTING PRISONERS; PREVENTING ESCAPE AND THE PROTECTION OF DESIGNATED PERSONNEL:
- > DEADLY FORCE WILL NOT BE USED ON ESCAPING DETAINEES EXCEPT AS A LAST RESORT WHEN THERE ARE NO OTHER MEANS OF AVAILABLE TO APPREHEND DETAINEE.
  - > GRADUATED RESPONSES SHOULD BE USED WHEN SITUATION PERMITS:
    - SHOUT- VERBAL WARNINGS TO HALT/STOP IN NATIVE LANGUAGE
    - SHOVE- PHYSICAL RESTRAIN, BLOCK ACCESS, OR DETAIN
    - SHOW- SHOW YOUR WEAPON AND DEMONSTRATE INTENT TO USE IT
    - SHOOT- SHOOT WARNING SHOT(S) (IF APPROPRIATE)
    - SHOOT- TO REMOVE THE THREAT OF DEATH/SERIOUS BODILY INJURY
  - > NECESSARY AND PROPORTIONAL FORCE, UP TO AND INCLUDING DEADLY FORCE IS ALWAYS AUTHORIZED IN SELF-DEFENSE OF COALITION FORCES. (OIF FRAGO 741)
- Designated personnel include, but are not limited to, innocent civilians, enemy prisoners of war, all civilian contractors, coalition forces, personnel from US and coalition government agencies, detainees from crimes committed by another detainee that are likely to cause death or serious bodily harm



**2BCT DETAINEE AND EPW  
TRAINING PACKAGE**

**AGENDA**



- I. DEFINITION OF A DETAINEE & EPW
- II. GENERAL OVERVIEW OF GENEVA CONVENTION WITH RESPECT TO PRISONERS OF WAR
- III. COMMAND POLICIES ON TREATMENT AND QUESTIONING OF DETAINEES
- IV. RULES OF ENGAGEMENT FOR DETENTION FACILITIES
- V. TRAINING VIGNETTES



**TRAINING VIGNETTES**

**PRINCIPLES TO REMEMBER**

1. GENERAL PROTECTIONS REQUIRED UNDER THE GENEVA CONVENTIONS (GPW)
2. SPECIFIC COMMAND POLICIES AND GENERAL ORDERS
3. ARMY DOCTRINE: THE 5 S's (AR 190-8, FM 27-10)
4. RULES OF ENGAGEMENT
5. COMMON SENSE = THE MISSION





**EPW/DETAINEE HANDLING**

APPLY FIVE (5) S's:

1. **Search:** (For weapons, intelligence)
2. **Silence:** (Discourages coordinated escape)
3. **Segregate:** (Separate male/female, military/civilian)
4. **Safeguard:** (Move personnel out of harm's way)
5. **Speed to the rear:** (Allow more advanced facility to carry the burden of EPWs)

TAG, TAG all personnel with DTG, capturing unit, location, circumstances, weapons, evidence obtained



**VIGNETTE # 1**

While on cordon and search, your platoon spots two Iraqis carrying AK 47's. One of them lifts his weapon and gets one round off before a member of your squad shoots and kills him. The other Iraqi begins to flee, but eventually stops, throws his weapon down and places his hands in the air to indicate surrender. You learn that one of the members of your platoon was struck in the leg by the enemy round? How do you handle the Iraqi that appears to be surrendering?



### RESPONSE # 1



- Approach the Iraqi with his hands the air with caution and treat as an EPW. Remember deadly force is only authorized if they continue to pose a threat. Enemy that indicates surrender is not a legitimate target until demonstrates a contrary intent.
- Apply the 5 S's. Use the minimum force necessary to gain control over the prisoner by ensuring that he has no other weapons. Place him in zip-ties or handcuffs.
- Ensure that the detainee is properly tagged (CPA Form), that sworn statements detailing his capture or provided and that any items taken from the detainee are noted on a DA Form 4137.
- Render medical attention as necessary. Treat remains of deceased Iraqis in accordance with 1AD FRAGO 62A.



### VIGNETTE # 2



Back at your Battalion Holding Facility, you are responsible for pulling security on detainees. One of the detainees continues to yell and scream and refuses to remain quiet as instructed. The other detainees are annoyed and begin to complain by banging and kicking their cells. How should you deal with this situation?



### RESPONSE # 2



- The detainee does not pose a physical threat to you, but is creating a disturbance in your facility. Ensure you follow facility SOP for security and request assistance from your NCOIC, OIC and an interpreter.
- Use the minimum amount of force to necessary to eliminate the disturbance. If practical, isolate the detainee.
- If he persists consider restraining. Do not gag the detainee unless you are certain he has no medical ailments. Monitor the other detainees closely and provide continuous sitreps if the disturbance persists.



### VIGNETTE # 3



You have a large number of detainees in your temporary holding facility. Several detainees begin to complain that they need water to wash up and that they wish to use the latrine. Your major concern is that more detainees are requesting to wash up and use the latrine than you have to ensure proper security. How should you deal with the situation?



### RESPONSE # 3



- Your facility should have schedule posted in Arabic to inform the detainees when they can expect to eat, bathe and use the latrine.
- Depending on the circumstances, you facility may have to vary these times. Use your SOP.
- Prioritize according to the needs of the detainees with particular attention to the needs of women, children, the elderly any detainees that may have a disability. Those who need to use the latrine take precedence over those that wish to wash up.
- Always provide medical attention when necessary



### VIGNETTE # 4



You are on guard shift at your holding facility, a 5-ton pulls up with new detainees for in-processing. You notice that one of the detainees is barely able to walk and appears to be in severe pain. In fact, his right leg appears to be broken. You review his CPA Apprehension Form and the sworn statements and learn that this detainee attacked another soldier in your Battalion and was injured as a necessary use of force in self-defense. What should you do?



### RESPONSE # 4



- Call for medical treatment for the detainee before in-processing any of the other detainees
- According to the Geneva Conventions, EPWs are given medical care in accordance with normal triage procedures. Based on the severity of the injury, this detainee should receive treatment as soon as possible.
- Secure the remainder of the detainees before completing your in-processing procedures, until a medic or surgeon arrives to assist.
- Note: If you suspect any abuse of detainees has occurred, report this immediately to the 2BCT Battle Captain



### VIGNETTE # 5



Same situation as before, except now it is 0330 and you are well into your guard shift at the facility. At 0315, you conducted your last walk-by to check on the status of each detainee. All seemed secure and asleep. Though it is late, you are alert and hear a noise coming from inside the facility towards one of the rear detainee cells. As you step through the alley-port, you see that one of the detainees is attempting to escape. He has taken his shirt off and is using in attempt to minimize his injuries has attempts to scale the concertina wire. What do you do?





### RESPONSE # 5



- Follow your Facility SOP for handling escape attempts. Notify QRF to cordon off the facility and prevent the detainee from leaving the immediate area.
- Use the minimum force necessary to recapture the detainee. Remember deadly force may only be used as a last resort. If there is a way to regain control of the detainee without resorting to deadly force, use it.
- Ensure that the remaining detainees are secured. Once recaptured apply the procedure for securing detainees and immediately provide a sitrep to higher.



### Quicky Vignettes



- 1.A. Detainee encouraged other detainees not to talk to interrogators. Can I put him in solitary confinement?
- 1.B. Detainee threatened to harm other detainees if they spoke with interrogators. Can I put her in solitary confinement?
2. Detainee keeps telling me that one of the US soldiers who detained him stole \$500 USD from him. What should I do?
3. Detainee, who is always causing trouble, demands a copy of the Koran. Must I give him one?
4. Detainee refuses to bathe. Can I force him to bathe?



### Quicky Vignettes



5. Detainee facility grounds are covered with standing water. Can I force detainees to squeegee the water off the concrete so they have a place to stand outside?
6. Detainee complains of stomach pains, but I think she is just trying to avoid interrogation. What should I do?
7. 2BCT delivered a detainee here without any shoes. What should I do?
8. 1BCT is attempting to deliver a detainee here without 2 Sworn Statements. What should I do?
9. Unarmed detainee is running out the front gate of the 1AD DIF (located at old DCT HQ). What should I do?
10. After 15 minute exercise break, detainee refuses to follow my order to get back in his cell. What should I do?



### FINAL THOUGHTS:



1. Handling Detainees is one of the most difficult missions in OIF.
2. Nothing good can come of mistreating people under your control.
3. Do not jeopardize a year of heroism for five minutes of frustration.

QUESTIONS??

UNCLASSIFIED

## Preserving Evidence Upon Detaining Civilians in Iraq

UNCLASSIFIED

Appendix 5 to Annex C (Mandatory Training) to FRAGO 44

1

UNCLASSIFIED

## Outline

- Current Situation
  - Bases for Detention and Release
  - Review by Magistrate for Continued Detention
  - Types of Evidence Considered by Magistrate
  - Coalition Provision Authority Forces Apprehension Form
  - Evidence/Property Custody Form
  - Sworn Statements
  - Groundrules for Transfer of Detainees
  - Additional Guidance Re Gray List Detainees
- UNCLASSIFIED

2

UNCLASSIFIED

## Situation

- More than 900 detainees currently being held at the Corps Holding Area
- Hundreds of others being detained in holding areas within MSC zones
- Most Iraqi criminal courts not currently operational. Coalition forces are holding all detainees until either
  - > release, or
  - > establishment of Iraqi court system and transfer to that system.
- Some detainees are being released because information known to soldiers in the capturing unit is not preserved and delivered to detention facilities.

UNCLASSIFIED

060645L May 03 3

UNCLASSIFIED

## Bases for Detention and Release

- Under ROE and V Corps FRAGOs, proper bases for initial detention include
    - > Looting (theft/destruction of property)
    - > More serious common crimes (murder, rape, assault, arson, etc.)
    - > Offenses against coalition forces (e.g. hostile acts, heavy weapons possession, interference with mission), and
    - > Possession of information valuable to the coalition's mission
  - Release is IAW V Corps FRAGO 006M to V Corps OPOD 0303-343:
    - > Release is automatic after 21 days unless
      - ✓ a review of their detention has occurred and
      - ✓ continued confinement is deemed necessary by a military magistrate
- UNCLASSIFIED

4

001054

1

174

UNCLASSIFIED

### Standard for Continued Detention Beyond 21 Days

Military magistrate deems continued confinement necessary if:

- probable cause that a crime has been committed or was about to be committed by, or with the aid of the detainee, or
- the detainee is interfering with, or
- is believed to possess information important to coalition mission accomplishment.

UNCLASSIFIED

5

UNCLASSIFIED

### Types of Evidence Considered by Magistrate

- Statements of Witnesses (preferably eyewitnesses) to Offense
  - "Testimonial Evidence"
- Things connected to Offense (e.g., weapons, documents)
  - "Physical Evidence"
- Accurate sketches, photographs of scene
  - "Demonstrative Evidence"

UNCLASSIFIED

6

UNCLASSIFIED

### Existing Guidance For Preserving Evidence

- Commanders will ensure capturing units provide complete information when turning in civilian internees, EPWs, or other detainees. At a minimum, provide the 5 W's:
  - Who
  - What
  - When
  - Where
  - Why
 as well as circumstances surrounding the capture.
- Information such as
  - names of witnesses,
  - contact numbers/addresses,
  - location of evidence, etc.
 will help in determining whether or not to release a CI/OD.
- For especially serious cases, *commanders may use military police assets to systematically capture data and evidence.*

UNCLASSIFIED

Corps Frago 93M, 6 May 03 7

UNCLASSIFIED

### Existing Guidance For Preserving Evidence

- Commanders will ensure capturing units provide complete information when turning in civilian internees, EPWs, or other detainees. At a minimum, provide the 5 W's:
  - Who
  - What
  - When
  - Where
  - Why
 as well as circumstances surrounding the capture.
- Information such as
  - names of witnesses,
  - contact numbers/addresses,
  - location of evidence, etc.
 will help in determining whether or not to release a CI/OD.
- For especially serious cases, *commanders may use military police assets to systematically capture data and evidence.*

UNCLASSIFIED

Corps Frago 93M, 6 May 03 8

NOT WORKING

Detainees still arriving at Camp Cropper or turned over to MPs with little or no information

**Coalition Provisional Authority Forces Apprehension Form**

- To be used in lieu of PW Capture Tag
- Intended to record information and preserve evidence
- Printed on tough, weatherproof cardstock
- Filled out with ball point pen
- Intended to be on the detainee from apprehension until arrival at Corps Holding Area
- Prompts tired or inexperienced soldier to provide needed specific information
- Employs block-checking where possible
- Yellow fields must be completed

UNCLASSIFIED

**Coalition Provisional Authority Forces Apprehension Form-- Backside**

- Records the 6-Ws—who, what, when, where, why, witnesses
- Must put specific identification and location information about other witnesses
- Includes space for other valuable information
- Should reference seizure of physical evidence
- Should reference collection of sworn statements

UNCLASSIFIED

**Form Instructions and Sample Completed Form**

COALITION PROVISIONAL AUTHORITY FORCES APPREHENSION FORM  
YELLOW FIELDS MUST BE FILLED IN, IF APPLICABLE, UPON APPREHENSION

Offense against Civilian(s) (check one) If "Other" then describe:

<input checked="" type="checkbox"/> Assault (I.P.C. 347)	<input type="checkbox"/> Burglary or Housebreaking (I.P.C. 421)
<input type="checkbox"/> Solicitation of Fornication/Prostitution (I.P.C. 399)	<input type="checkbox"/> Sedition/Communicating Threats (I.P.C. 430)
<input type="checkbox"/> Rape/Indecent Sexual Assaults (I.P.C. 355-96, 402)	<input type="checkbox"/> Theft (I.P.C. 436)
<input type="checkbox"/> Murder (I.P.C. 405)	<input type="checkbox"/> Destruction of Property (I.P.C. 477)
<input type="checkbox"/> Aggravated Assault with Harm To HS (I.P.C. 410)	<input type="checkbox"/> Obstructing Public Highway/Place (I.P.C. 487)
<input type="checkbox"/> Hazing (I.P.C. 412)	<input type="checkbox"/> Discharging Firearm/Explosive in City/Town/Village (I.P.C. 495)
<input type="checkbox"/> Simple Assault (I.P.C. 415)	<input type="checkbox"/> Riot or Breach of Peace (I.P.C. 495(3))
<input type="checkbox"/> Kidnapping (I.P.C. 421)	<input type="checkbox"/> Other

Offense against Coalition Forces (check one) If "Other" then describe:

<input checked="" type="checkbox"/> Violation of Curfew	<input type="checkbox"/> Trespass on Military Installation or Facility
<input type="checkbox"/> Illegal Possession of Weapon	<input type="checkbox"/> Photographing/Surveillance Military Installation or Facility
<input type="checkbox"/> Assault/Attack on Coalition Forces	<input type="checkbox"/> Obstructing Performance of Military Mission
<input type="checkbox"/> Theft of Coalition Force Property	<input type="checkbox"/> Other

- Soldiers are apprehending detainees under the legal authority of the Coalition Provisional Authority for Iraq, which upholds Iraqi laws that remain valid and which prohibits offenses against Coalition Forces
- Apprehending soldier checks applicable offense(s) with ball point pen
- "Looting" is not a formal crime—it typically is some combination of Theft, Housebreaking, Destruction of Property, and Riot or Breach of Peace
- I.P.C. is the abbreviation for the Iraqi Penal Code of 1969

UNCLASSIFIED

**Form Instructions and Sample Completed Form**

Apprehending Unit: 1 <sup>st</sup> Pz/B Co/2-6 Inf/1 AD	Location Grid: MB 43844 86940
Date of Incident: (DD/M/Y) 29 07 /03 to 30 07 /03 2350 hrs to 0010 hrs	Date of Report: (DD/M/Y) 30 07 /03 Time of Report: 0045 hrs

- Provide complete unit identification, down to platoon level
- Give full 10 digit grid, if PLGR available; otherwise extract 8 digit grid from mapsheet; street location and other location information should be provided on backside of form
- Provide precise date/time information. Space is provided if period of incident straddles midnight.

UNCLASSIFIED

~~UNCLASSIFIED~~

### Form Instructions and Sample Completed Form

Detainee # <u>1AD-JUL03-0255</u>		Key Connected Person: <input type="checkbox"/> Victim <input checked="" type="checkbox"/> Witness	
Last Name: <u>Kubba</u>		Last Name: <u>Razak</u>	
First Name: <u>Ghaleb</u>	Given Name:	First Name: <u>Fatimah Noor</u>	Given Name:
Hair Color: <u>Black</u>	Scars/Tattoos/Deformities: <u>Fedayeen Tattoo on l. arm</u>	Hair Color: <u>Black</u>	Scars/Tattoos/Deformities: <u>1" White Scar on l. cheek</u>
Eye Color: <u>Brown</u>	Weight: <u>65 lb</u>	Eye Color: <u>Green</u>	Weight: <u>120 lb</u>
Address: <u>Raqdah Municipality</u>	Place of Birth: <u>Tikrit</u>	Address: <u>Korh Municipality</u>	Place of Birth: <u>Bohdad City</u>
Ethnicity: <u>Sunnit</u>	Sex: <input checked="" type="checkbox"/> M <input type="checkbox"/> F	Ethnicity: <u>Shia</u>	Sex: <input checked="" type="checkbox"/> M <input type="checkbox"/> F
DOB: <u>04/07/78</u>	DOB: <u>06/03/65</u>	DOB: <u>06/03/65</u>	DOB: <u>06/03/65</u>
Phone: <u>9078588</u>	Phone: <u>5152089</u>	Phone: <u>5152089</u>	Phone: <u>5152089</u>
Document #: <u>9078588</u>	Document #: <u>7878894</u>	Document #: <u>7878894</u>	Document #: <u>7878894</u>
Total Number of Persons Involved: <u>4</u> (List names/identifying info on reverse under "Additional Helpful Information")			

- Detainee number is assigned by the MSC headquarters. This detainee is the 255<sup>th</sup> apprehended by 1<sup>st</sup> Armored Division in the month of July 03.
- Fill in all identifying information available.
- The "Key Connected Person" is the one other Iraqi person a judge could talk to in order to establish what happened. Fill in all identifying information for that person too.

~~UNCLASSIFIED~~ 13

~~UNCLASSIFIED~~

### Form Instructions and Sample Completed Form

<input checked="" type="checkbox"/> Vehicle Information		Vehicle Number <u>1</u> of <u>1</u> Vehicle(s)	Owner: <u>Ghaleb Kubba</u>
Make: <u>Kamaz</u>	Color: <u>Red</u>	VIN: <u>XJGB9868B73367G199980214</u>	
Model: <u>4326</u>	Type: <u>Truck</u>	Plate No.: <u>122008</u>	Number of People in Vehicle: <u>1</u>
Year: <u>1982</u>	Names of People in Vehicle: <u>Ghaleb Kubba</u>		
Contraband/Weapons in Vehicle: <u>AK-47</u>			

- Vehicles can provide important evidence.
- Fill in all identifying information available.

~~UNCLASSIFIED~~ 14

~~UNCLASSIFIED~~

### Form Instructions and Sample Completed Form

<input checked="" type="checkbox"/> Property/Contraband	<input checked="" type="checkbox"/> Weapon	Photo Taken of Suspect with Weapon/Contraband: <u>Yes</u> <input checked="" type="checkbox"/> <u>No</u> <input type="checkbox"/>	
Type: <u>Auto Asslt Rifle</u>	Model: <u>AK-47</u>	Color/Caliber: <u>7.62mm</u>	
Serial No.: <u>1357007</u>	Quantity: <u>1</u>	Make: <u>Kalashnikov</u>	Receipt Provided to Owner: <u>Yes</u> <input checked="" type="checkbox"/> <u>No</u> <input type="checkbox"/>
Other Details: <u>3 notches in stock</u>		Where Found: <u>Red Komoz</u>	Owner: <u>unk</u>

- Weapons are crucial evidence that must be identified and then separately marked and backhauled.
- If time and circumstances permit, a separate Property/Custody document will be filled out pertaining to seized weapons.

~~UNCLASSIFIED~~ 15

~~UNCLASSIFIED~~

### Form Instructions and Sample Completed Form

Name of Assisting Interpreter: <u>Mehdi al Halaf</u>		Email, Phone, or Contact Info: <u>4228616</u>	
Detaining Soldier's Name (Print):	<u>Schmartz, SGT Jack S.</u>	Supervising Officer's Name (Print):	<u>Gregg, 1LT Phillip E.</u>
	Last, First, MI		Last, Rank, First, MI
Signature:	<u>Jack S. Schmartz</u>	Signature:	<u>Phillip E. Gregg</u>
Email: <u>jack.schmartz@us.army.mil</u>		Email: <u>phillip.gregg@us.army.mil</u>	
Unit Phone: <u>551-0552</u>	Date: <u>07/30/03</u>	Unit Phone: <u>551-0516</u>	Date: <u>07/30/03</u>

- Identify the interpreter, if any, who assisted in collecting information. Ensure contact information is captured.
- The one soldier who was most involved in taking the person into custody prints his name and contact information on the lower left of the CPA Forces Apprehension Form and signs.
- The first commissioned officer in the detaining soldier's chain of command prints his name and contact information on the lower right of the CPA Forces Apprehension Form and signs.

~~UNCLASSIFIED~~ 16

**UNCLASSIFIED**

### Form Instructions and Sample Completed Form

○ COALITION PROVISIONAL AUTHORITY FORCES APPREHENSION FORM ○

Why was this person detained? At approx 292350, 1st Platoon was conducting a patrol in Zone J. SGT Schmatz heard a woman yelling and upon turning the corner saw the woman pointing to a neighboring building. He then saw D running from the building carrying what looked like electrical wiring and light fixtures. PFC Schmatz and crew of his M1114 chased D, who ran to a red truck, reached in, and then fired a burst of 5-8 rounds from a rifle he pulled out.

Who witnessed this person being detained or the reason for detention? Give names, contact numbers, addresses. The woman who yelled to SGT Schmatz was Fatimah Noor Razak, who had seen D break the door and then rip out the light fixtures and all electrical wiring from the neighboring house, which was empty at the time. Razak's two minor children, Anwar Abdul Razak (18) and Amed Ali Razak (16) also witnessed part of D's activities in the neighboring house. In addition to the three members of the Razak family, three other soldiers who were with SGT Schmatz saw parts of the chase and apprehension of D. These were PFC Jason K. But, SPC Harvey L. Wilshire, and PV2 Herman L. Mulville, all of the same platoon and contact information as SGT Schmatz.

- Provide the reason for the detention in a brief narrative.
- Ensure that all key witnesses are identified.

**UNCLASSIFIED** 17

**UNCLASSIFIED**

### Form Instructions and Sample Completed Form

How was this person traveling (car, bus, on foot)? By foot. He appears to have arrived in the area by vehicle.

Who was with this person? No one. He appears to have been acting on his own.

- In the sample case, the individual detained is a lone offender.
- When two or more individuals are acting together, it is important to annotate this and to identify other detainees by detainee number.

**UNCLASSIFIED** 18

### Form Instructions and Sample Completed Form

What weapons was this person carrying? AK 47, which was fired at coalition forces. See front. Upon search of the vehicle, an RPG was found. Both the rifle and the RPG were evacuated to the Corps Holding Area and evidence/custody forms were completed and annotated with detainee number.

What contraband was this person carrying? Stolen electrical fixtures and wiring. Arms were full with a tangle of wires and light sockets. D's capture was made easier because he could not move as quickly with full arms. The property was evacuated with the detainee and tagged with an evidence/custody form and the detainee number.

- Any additional weapons, not mentioned on the front should be described on the back side.
- Describe other contraband or evidence. Annotate whether Evidence/Property Custody Documents (DA Forms 4137) have been completed and ensure that evidence is linked to the detainee by marking with detainee number.

**UNCLASSIFIED** 19

### Form Instructions and Sample Completed Form

What other weapons were seized? RPG, from vehicle.

What other information did you get from this person? Detainee claimed that his own house was looted by the occupant of the home he was stealing the wiring from. D claimed that he simply want to get his own house running again. D also claimed that he was not firing at coalition troops but that he had been fired upon by another Iraqi. 1st Platoon could find no evidence to support this claim.

Additional Helpful Information: Fatimah Noor Razak and her two sons, Anwar Abdul Razak and Amed Ali Razak had excellent recall of events. They stated that D had torn down the door to the home next door to theirs at around 2330 and that he proceeded to rip out ceiling tiles to get at the electrical wires. They were able to see his actions through a broken, uncovered window directly across the alleyway between houses. The Razak family is from this part of Baghdad City and has no intention of relocating, so they should be reachable as witnesses for the medium term. They can identify D by face and by the tattoo he has on his left arm. They can also identify the weapon he carried (it contained 3 notches on it) and the bundle of wires and fixtures he removed from the house. Finally, they can remember the car he ran to and the weapon he retrieved and fired. DA Form 2623 Sworn Statement was provided by Fatimah.

- Be sure to describe any likely defenses or extenuation/mitigation the detainee might raise.
- If there is no evidence to support such defenses or extenuation/mitigation, say so.

**UNCLASSIFIED** 20

**DA Form 4137—  
Evidence/Property  
Custody Document**

- Records the seizure of evidence associated with a crime.
- Captures date-time of seizure, as well as any transfers in custody.
- Ensures that transfers are controlled and recorded.
- Standard Army Form; should stay with the evidence until signed for at detention facility evidence room.

21

**Form Instructions and Sample Completed Form**

- Use detainee number in upper right hand corner to identify the case the evidence is connected with.
- Use 1 form for all evidence seized.

22

**Form Instructions and Sample Completed Form**

DATE	TIME	INITIALS	REMARKS
1.2.30	Jul	Jack S. Schmatz	Owen W. Smith
3.4.03		Schmatz, SGT Jack S.	Smith, SSG Owen W.
1.2.30	Jul	Owen W. Smith	Benjamin R. Freemyer
3.4.03		Smith, SSG Owen W.	Freemyer, SGT Benjamin R.
1.2.31	Jul	Benjamin R. Freemyer	Jeremy K. Roller
3.4.03		Freemyer, SGT Benjamin R.	Roller, SFC Jeremy K.

- Record who is in custody of evidence as it is backhauled to the Corps Holding Area, with signatures.

23

**DA Form 2823—  
Sworn Statement**

- Records what witnesses, saw, heard, felt, and smelled.
- Should answer the 6 W's— who, what, when, where, why, and witnesses.
- Should answer the question, "did [the detained individual] commit a crime?"
- Sworn to be the truth before a commissioned officer

24

# COALITION PROVISIONAL AUTHORITY FORCES APPREHENSION FORM

YELLOW FIELDS MUST BE FILLED IN, IF APPLICABLE, UPON APPREHENSION

<input type="checkbox"/> <b>Offense against Civilian(s) [check one] If "Other" then describe:</b> _____	
<input type="checkbox"/> Arson (I.P.C. 342)	<input type="checkbox"/> Burglary or Housebreaking (I.P.C. 428)
<input type="checkbox"/> Solicitation of Fornication/Prostitution (I.P.C. 399)	<input type="checkbox"/> Extortion/Communicating Threats (I.P.C. 430)
<input type="checkbox"/> Rape/Indecent/Sexual Assaults/Acts (I.P.C. 393-98, 402)	<input type="checkbox"/> Theft (I.P.C. 439)
<input type="checkbox"/> Murder (I.P.C. 405)	<input type="checkbox"/> Destruction of Property (I.P.C. 477)
<input type="checkbox"/> Aggravated Assault/Assault With Intent To Kill (I.P.C. 410)	<input type="checkbox"/> Obstructing a Public Highway/Place (I.P.C. 487)
<input type="checkbox"/> Maiming (I.P.C. 412)	<input type="checkbox"/> Discharging Firearm/ Explosive in City/Town/Village (I.P.C. 495)
<input type="checkbox"/> Simple Assault (I.P.C. 415)	<input type="checkbox"/> Riot or Breach of Peace (I.P.C. 495(3))
<input type="checkbox"/> Kidnapping (I.P.C. 421)	<input type="checkbox"/> Other

<input type="checkbox"/> <b>Offense against Coalition Forces [check one] If "Other" then describe:</b> _____	
<input type="checkbox"/> Violation of Curfew	<input type="checkbox"/> Trespass on Military Installation or Facility
<input type="checkbox"/> Illegal Possession of Weapon	<input type="checkbox"/> Photographing/Surveilling Military Installation or Facility
<input type="checkbox"/> Assault/Attack on Coalition Forces	<input type="checkbox"/> Obstructing Performance of Military Mission
<input type="checkbox"/> Theft of Coalition Force Property	<input type="checkbox"/> Other

Apprehending Unit: _____		Location Grid: _____	
Date of Incident: (D/M/Y)	Time of Incident:	Date of Report: (D/M/Y)	Time of Report:
/ / to / /	hrs to hrs	/ /	hrs

Detainee # _____		Key Connected Person: <input type="checkbox"/> Victim <input type="checkbox"/> Witness	
Last Name: _____		Last Name: _____	
First Name: _____ Given Name: _____		First Name: _____ Given Name: _____	
Hair Color: _____	Scars/Tattoos/Deformities: _____	Hair Color: _____	Scars/Tattoos/Deformities: _____
Eye-Color: _____	Weight: lb	Height: in	Eye-Color: _____
Address: _____		Address: _____	
Place of Birth: _____		Place of Birth: _____	
Ethn/Tribe/ Sect:	Sex: <input type="checkbox"/> M <input type="checkbox"/> F	Phone#: DOB D/M/Y: <input type="checkbox"/> Mobile <input type="checkbox"/> Regular	Ethn/Tribe/ Sect:
<input type="checkbox"/> Passport <input type="checkbox"/> Dr. license <input type="checkbox"/> Other (specify)	<input type="checkbox"/> Passport <input type="checkbox"/> Dr. license <input type="checkbox"/> Other (specify)	Document #:	Document #:

Total Number of Persons Involved \_\_\_\_\_ (list names/identifying info on reverse under "Additional Helpful Information")

<input type="checkbox"/> <b>Vehicle Information</b>	Vehicle Number _____ of _____ Vehicle(s)	Owner: _____
Make: _____	Color: _____	VIN: _____
Model: _____	Type: _____	Plate No.: _____
Year: _____	Names of People in Vehicle: _____	
Contraband/Weapons in Vehicle: _____		

<input type="checkbox"/> Property/Contraband	<input type="checkbox"/> Weapon	Photo Taken of Suspect with Weapon/Contraband: Yes/ No
Type: _____	Model: _____	Color/Caliber: _____
Serial No.: _____	Quantity: _____	Make: _____
Other Details: _____	Where Found: _____	Owner: _____

Name of Assisting Interpreter: \_\_\_\_\_ Email, Phone, or Contact Info: \_\_\_\_\_

Detaining Soldier's Name (Print): _____	Supervising Officer's Name (Print): _____
Last, First MI	Last, First MI
Signature: _____	Signature: _____
Email: _____	Email: _____
Unit Phone: _____	Unit Phone: _____
Date: / /	Date: / /

001060





COALITION PROVISIONAL AUTHORITY FORCES APPREHENSION FORM



Why was this person detained? \_\_\_\_\_  
\_\_\_\_\_  
\_\_\_\_\_

Who witnessed this person being detained or the reason for detention? Give names, contact numbers, addresses.  
\_\_\_\_\_  
\_\_\_\_\_  
\_\_\_\_\_  
\_\_\_\_\_  
\_\_\_\_\_  
\_\_\_\_\_

How was this person traveling (car, bus, on foot)? \_\_\_\_\_  
\_\_\_\_\_

Who was with this person? \_\_\_\_\_  
\_\_\_\_\_

What weapons was this person carrying? \_\_\_\_\_  
\_\_\_\_\_  
\_\_\_\_\_

What contraband was this person carrying? \_\_\_\_\_  
\_\_\_\_\_  
\_\_\_\_\_

What other weapons were seized? \_\_\_\_\_  
\_\_\_\_\_  
\_\_\_\_\_

What other information did you get from this person? \_\_\_\_\_  
\_\_\_\_\_  
\_\_\_\_\_

Additional Helpful Information: \_\_\_\_\_  
\_\_\_\_\_  
\_\_\_\_\_  
\_\_\_\_\_  
\_\_\_\_\_  
\_\_\_\_\_  
\_\_\_\_\_

Table Of Maximum Period of Pre-Trial Detention for Minor Offenses

Unless earlier tried, released, bound over for trial by competent Iraqi judicial authority, or further detained on order of a Coalition Forces General Officer commander, civilians detained for the following offenses will be detained no longer than the periods specified:

<u>Offense</u>	<u>Maximum Period of Pre-Trial Detention</u>
Curfew Violation	24 Hours
Speeding/Other Traffic Violations	24 Hours
Discharge of Weapon in City Limits	10 Days
Drunk and Disorderly	10 Days
Interference with Mission Accomplishment By Violating Lawful Order of Coalition Soldier in the Performance of Official Duties	14 Days
Petty Theft (Theft of Item of Value of \$20 or less)	14 Days
Simple Assault	14 Days

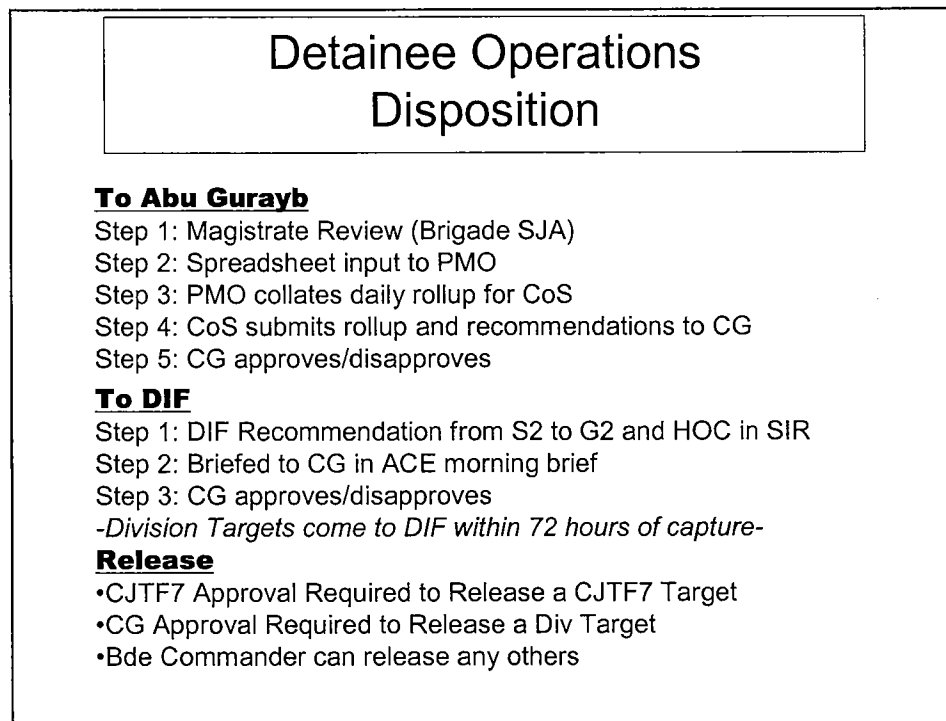
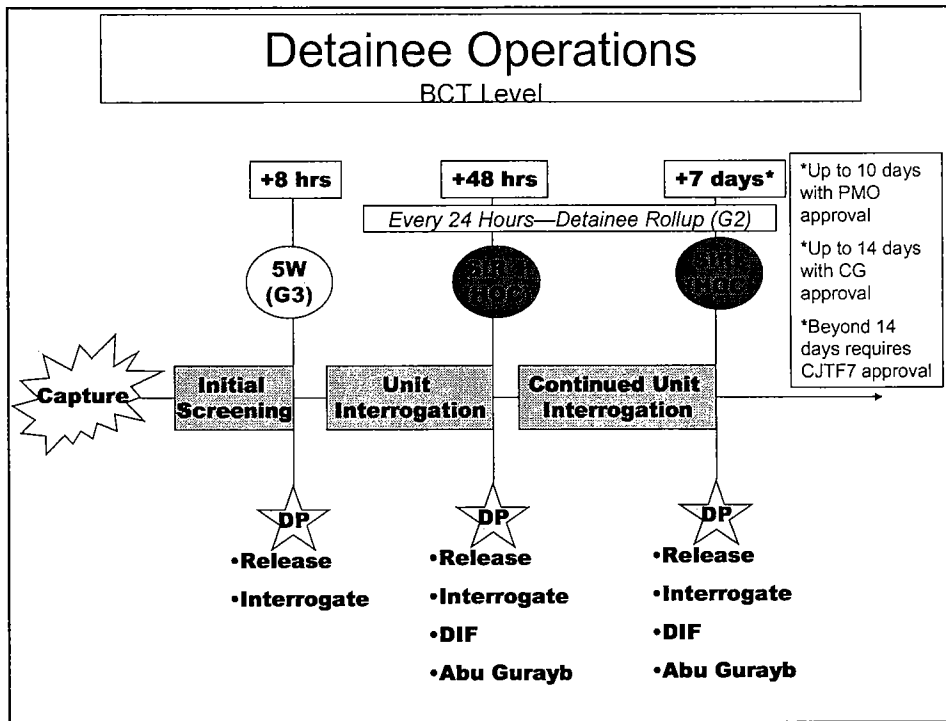

# DETAINEE PROCESS

## AGENDA

- PURPOSE
- TYPES OF DETAINEES
- DETAINEE FLOW
- TIMELINE
- DETAINEE/INFORMATION FLOW
- HOLDING AREA PURPOSE
- HOLDING AREA APPROVAL AUTHORITY
- REQUIRED DOCUMENTATION
- THE WHY FOR A RHA
- VIGNETTES
- QUESTIONS

## PURPOSE

- TO INFORM SQUADRON COMMANDERS OF THE TASK, CONDITIONS, AND STANDARDS OF THE DETAINEE SOP.

## TYPES OF DETAINEES

- CRIMINAL DETAINEE
  - SUSPECTED OF HAVING COMMITTED A CRIME AGAINST IRAQI NATIONALS OR PROPERTY AND NOT RELATED TO COALITION FORCES
- SECURITY DETAINEE
  - POSE A THREAT TO THE SECURITY OF COALITION FORCES OR THEIR MISSION
- DETAINEES OF INTEL VALUE
  - DETAINEES IDENTIFIED AS HAVING INTELLIGENCE VALUE THAT WARRANTS FURTHER INTERROGATION

# TYPES OF DETAINEES

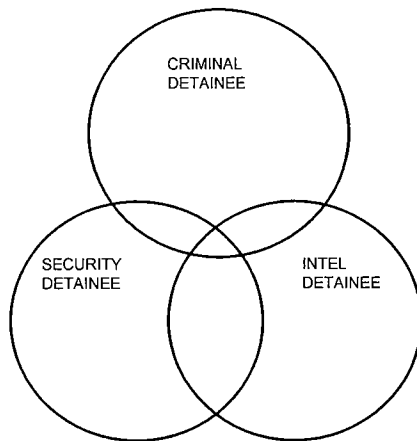

# DETAINEE FLOW

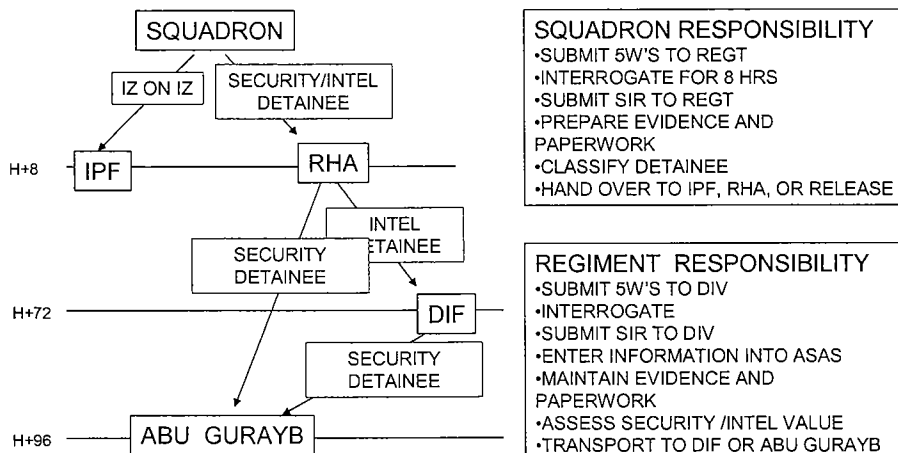

# TIMELINE

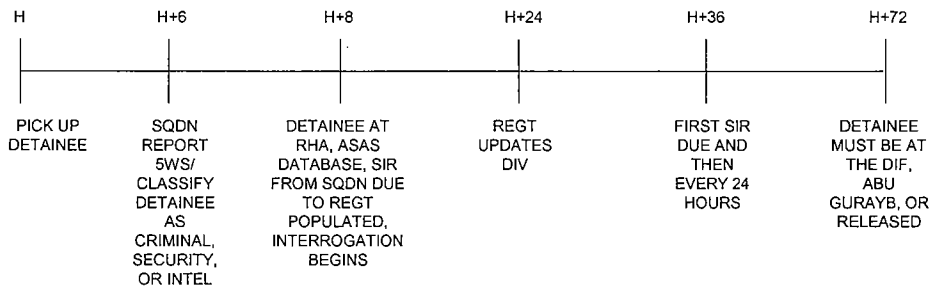

TIMELINE SUBJECT TO HIGHER INTERVENTION

# DETAINEE/ INFORMATION FLOW

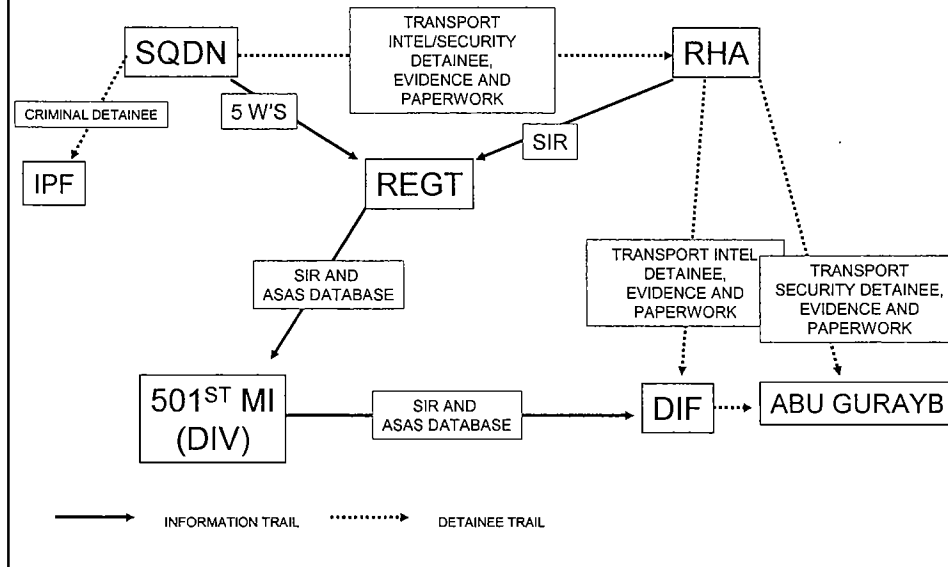

## HOLDING AREA PURPOSE

- REGIMENTAL HOLDING AREA (RHA)
  - ONLY SECURITY/ INTEL DETAINEES GO TO THE RHA WITH APPROVAL FROM REGT; ALL OTHER ARE HANDED OVER TO IPF.
- DIVISION INTERROGATION FACILITY (DIF)
  - ONLY DETAINEES WITH INTEL VALUE OR SECURITY DETAINEES WITH INTEL VALUE
- COALITION INTERROGATION FACILITY (CIF)
  - ONLY DA BLACK LIST DETAINEES
- ABU GURAYB
  - SECURITY DETAINEES

## HOLDING AREA APPROVAL AUTHORITY

- REGIMENTAL HOLDING AREA (RHA)
  - REGIMENTAL COMMANDER
  - SQUADRON COMMANDERS MAKE RECOMMENDATION
- DIVISION INTERROGATION FACILITY (DIF)
  - DIVISION COMMANDER THRU THE 501<sup>ST</sup> MI BN, S3
  - REGIMENTAL COMMANDER MAKES RECOMMENDATION
- COALITION INTERROGATION FACILITY (CIF)
  - C-JTF7 COMMANDER
- ABU GURAYB
  - DIVISION COMMANDER THRU THE 501<sup>ST</sup> MI BN, S3
  - REGIMENTAL COMMANDER MAKES RECOMMENDATION



## REQUIRED DOCUMENTATION

- REGIMENTAL HOLDING AREA (RHA)
  - SQUADRON SUMMARY INTERROGATION REPORT (SIR)
  - CPA APPREHENSION FORM
  - DA FORM 2823 (SWORN STATEMENT)\*2
  - DA FORM 4137 (EVIDENCE/PROPERTY CUSTODY)
    - POPULATE ASAS DATABASE
    - EVIDENCE
  
- DIVISION INTERROGATION FACILITY (DIF)
  - SUMMARY INTERROGATION REPORT (SIR)
  - CPA APPREHENSION FORM
  - DA FORM 2823 (SWORN STATEMENT)\*2
  - DA FORM 4137 (EVIDENCE/PROPERTY CUSTODY)
    - EVIDENCE

## REQUIRED DOCUMENTATION

- ABU GURAYB
  - SUMMARY INTERROGATION REPORT (SIR)
  - CPA APPREHENSION FORM
  - DA FORM 2823 (SWORN STATEMENT)\*2
  - DA FORM 4137 (EVIDENCE/PROPERTY CUSTODY)
    - EVIDENCE

## THE WHY

- ENSURE STANDARDS FOR DETAINEES GOING HIGHER ARE MET
  - PAPERWORK
  - EVIDENCE
  - SIRS
  - ASAS DATABASE
- ECONOMY OF FORCE FOR SQUADRONS
  - GUARD REQUIREMENTS
  - TRANSPORTATION TO DIF/ABU GURAYB
- MALE/ FEMALE FACILITY
- MEDICAL SUPPORT ON SITE
- DEDICATED INTERROGATION TEAM
  - 97 SERIES SOLDIER PERMANENTLY ON SITE
  - CAT II LINGUIST PERMANENTLY ON SITE
- ACCURATE TRACKING OF DETAINEE HISTORY

## VIGNETTES

- IZ IS DRUNK AND SHOOTS AT AND MISSES A PATROL.
- IZ IS SEEN ON THE SIDE OF THE ROAD WITH SEVERAL RPG'S.
- IZ IS FOUND WITH FAKE PASSPORTS.
- IZ SHOOTS AT ANOTHER IZ AND HITS A SOLDIER.
- VEHICLE IS STOPPED AT AN IZ/US CHECKPOINT WITH LARGE SUMS OF COUNTERFEIT DINAR.

# QUESTIONS



**DEPARTMENT OF THE ARMY**  
REGIMENTAL SUPPORT SQUADRON  
2D ARMORED CAVALRY REGIMENT  
CAMP MULESKINNER, BAGHDAD, IRAQ (OIF)



AFZX-CS-S2

18 December 03

MEMORANDUM FOR CONCERNED PERSONNEL

Subject: RSS/RHA Detainee Holding Area Guidance

References:

- a. OPOD 03-06 [Procedures for detainees of intelligence interest and criminal detainees]
- b. 2 ACR FRAGO 139 [Regimental Holding Area]
- c. ENCLOSURE 1 [Min Standards for Brigade Holding Areas] FRAGO 539A, OPOD 03-215
- d. 1 AD PAM 1-201 Command Inspection Checklist [Detainee Holding Facilities] September 2003

1. Regimental Support Squadron (RSS) will maintain the Regimental Detainee Holding Area (RHA). This guidance will assist in the daily operations of the Facility and ensure its compliance with International Humanitarian Law. RHA personnel will treat the detained personnel with dignity and respect and will handle all detainees with the minimum force necessary as required by the situation.
2. RHA personnel will not assume responsibility for any detainee until such time that all required documentation has been correctly filled out and all personal effects have been inventoried, cataloged, and stored. When appropriate, detainees will be segregated based upon their individual status. Criminal detainees must be segregated from EPWs and internees held for intelligence or security reasons.
3. A RHA advisory counsel will meet NLT 0800 hrs daily to review the detainee case files to ensure compliance with established procedures and that the detainee is processed and ready to be transferred or released. At a minimum, the counsel will consist of the Squadron S-2, and Assistant Operations Officer, and RHA NCOIC. No detainee will be moved, transferred or released from the RHA without the RSS Squadron Commander's approval.
4. RHA guard force will maintain a ratio of 5:1 between detainees and guards with a minimum of 2 guards present at all times. The RHA NCOIC will maintain the guard roster and will ensure that it is posted weekly. At no other time will the roster be altered without the approval of the RHA NCOIC. Sections tasked to provide guards will ensure that the RHA NCOIC is notified of planned missions that require the roster to be altered. Sections will not pull guards without ensuring that there is a replacement.
5. RHA NCOIC will ensure that one guard is on roving duty monitoring the activities of the detainees in their respective cells at all times. This guard will record their initials and time of their check, at a minimum every 30 minutes on the cell inspection form. If available a second guard will be utilized as an outdoor roving guard to ensure secondary perimeter security.
6. At a minimum, the RHA guard force will:
  - a. Treat all detainees with dignity and respect. Detained Foreign Military Officers will be treated as appropriate to their rank.
  - b. Handle all detainees with the minimum force necessary as required by the situation. No form of abuse, physical or mental (including the use of abusive language), will be directed at the detainees.
  - c. Interior guards will check all cells with detainees constantly. At least once every 30 minutes checks will be recorded on cell logs. Guards coming onto shift will ensure the presence of all detainees and their compliance of established guidelines as brief to them upon their reception at RHA.

001072

- d. If a detainee is unaccounted, at any time guards, will IMMEDIATELY report the absence to the Shift NCOIC who will in turn notify Camp Muleskinner FPC at DNVT: 587-5027.
- e. Prior to shift change the outgoing Shift NCOIC will conduct a full inspection of the RHA area and conduct a prisoner count with the incoming Shift NCOIC present. Only after inspections are complete and detainees are accounted for will the outgoing NCOIC and Guards be relieved of duty.
- f. Guards will read and review all special instructions prior to assuming guard duties in RHA.
- g. Ensure that detainees maintain the cleanliness of their respective holding cell. The guard force is responsible for the cleanliness of the common areas and police call around the RHA. Police call and trash removal will be conducted at the change of shifts. Daily inspections of cells will be conducted to ensure integrity, security, and cleanliness of the cells. Any attempts to weaken the cells will result in the detainee being restrained (zip-tied) and removed from the cell so that repairs / corrections can be made.
- h. Ensure that the detainees are provided meals (MREs) and water throughout their shift. Meals will be given out at 0800, 1200, and 1800 hours daily. Empty water bottles will be filled and given to each detainee upon request. Guards will ensure there is enough potable water on hand to re-fill the bottles as needed.
- i. Maintain and enforce the uniform policy. The uniform for inside the RHA is DCUs, but may be upgraded as the situation dictates. At no time will the guards remove their blouse while on duty. RHA guards will enforce this standard.
- j. While out of the ready room guards will not eat, drink soft drinks, read, write letters, or conduct any other business that may distract them while on duty. Guards will perform their duties IAW FM 22-6 and established procedures. Guards are not permitted to leave the RHA without ensuring that the detainee guard ration is maintained. Guards will be permitted to leave the RHA to use the latrine, however, they are not permitted to go to the barracks/ sleeping areas to wake up the next shift.
- k. Maintain an "Amber" weapon status with magazine in well and the selector switch on safe. Upon shift change, the off going guards will move to the nearest clearing barrel and clear their weapon. Guards will maintain positive control of their weapons while on duty. At no time will the weapon be left unattended or under the control of another guard.
- l. The Stand-by guards will escort detainees being transferred to the DIF or Corps Holding Area. The only exception it this is when all detainees are being transferred the current shift will provide the escort.

7. Upon arrival and while detained the detainees will:

- a. Be interviewed by the RHA NCOIC, CI agent, or Squadron S-2 and screened for medical problems or signs of physical abuse.
- b. Have any restraints (hand-cuffs, zip-ties) replaced so that their hands are in front. Zip-ties will be placed so that they secure the detainee's hands, but not to the extent that they pose a medical risk. Restraining devices will be used until the detainee is determined that he/she is no longer a security risk. This determination will be made during the interview with S-2 or CI personnel.
- c. No talking until after the completion of the initial interview. If a detainee refuses to adhere to this policy, the RHA guards are authorized to gag them. By taping his / her mouth. The gag will not be placed so that it poses a medical risk. Detainees will be briefed on this policy upon arrival with the assistance of a qualified translator.
- d. Be permitted, after the initial interview, to walk freely around their respective cell. They will not be permitted outside of the cell unless under escort. The only authorized reasons for leaving the cell are to use the latrine, to be moved for questioning, or as directed by the chain of command.
- e. Be permitted, upon completion of the initial interview, to conduct religious activities (pray). If needed, the RHA guards will un-bind the detainee's hands.

8. If any medical issue is identified, the RHA NCOIC will be notified and proper medical treatment will be given. The medics on site will assess the EPW to determine what is needed. If determined that the detainee has to be transferred to the medical treatment facility, RSS, Transportation will be provided with guards to RSS. The medic will stay with the patient as needed to brief the on call PA of symptoms found.

001073

9. If adequate supplies are available, detainees will be permitted to conduct personal hygiene in the morning under the supervision of the RHA guards.

10. Requests for special privileges, such as smoking, will be brought to the attention of the RHA NCOIC, Squadron Assistant Operations Officer, S-2, or chain of command for action. The decision will be made based on the detainee's status and overall demeanor/ level of cooperation.

11. All EPWs that are of 17 years or younger and or female will be put in a separate cell. At no time will a male soldier search a female EPW. A female soldier will be requested if not available to conduct the search in the presence of an NCO and a translator. At no time will this ever be negotiated to save time.

12. While in the RHA, the detainee will be treated within the guideline established under international humanitarian law and through military channels. RHA guards are permitted to use the appropriate force, including deadly force, if needed. If force is used, it will be reported and if need, an investigation will be conducted by the command. If determined that excessive force or any form of abuse was used on the detainees, the person or persons can be subject to disciplinary actions under the Uniformed Code of Military Justice.

13. Point of contact for this policy memorandum is (

Personal Info Redacted IAW Sec of Def Memo 01-  
CORR-101, dtd 9 Nov 01

001074



**DEPARTMENT OF THE ARMY**  
REGIMENTAL SUPPORT SQUADRON  
2D ARMORED CAVALRY REGIMENT  
CAMP MULESKINNER, BAGHDAD, IRAQ (OIF)

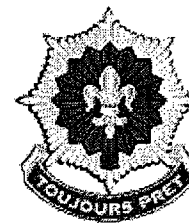

AFZX-CS-S2

18 December 03

MEMORANDUM FOR CONCERNED PERSONNEL

Subject: RSS/RHA Special Instructions

1. As soldiers and Dragoons, we are expected to maintain our professional standards and individual discipline at all times. Every soldier should execute a high level of initiative, competence, pride and professional excellence in all that we do. Teamwork is the basic building block of RSS and it will take each individual doing a little extra to enable us to accomplish our mission in a professional manner.
2. At a minimum, the RHA guard force will read and review on a daily basis the follow list of special instructions thereby ensuring that they understand their duties as a guard at the RHA.

Basic Duties:

- a. Guards will perform their duties IAW FM 22-6 and established procedures.
- b. Treat all detainees with dignity and respect.
- c. Prisoners shall be separated according to Sex, Rank, Age, Criminal, and intelligence detainees. Detained Foreign Military Officers will be treated as appropriate to their rank.
- d. Handle all detainees with the minimum force necessary as required by the situation. No form of abuse, physical or mental (including the use of abusive language), will be directed at the detainees.
- e. All prisoners will be searched upon reception, every two days (if held beyond 72 hours), and upon transfer to another facility. Ensure that the detainee is not retaining any weapons, personal property, food, tobacco products, or hazardous items (i.e. belts, and shoelaces).
- f. RHA guard force will maintain a ratio of 5:1 between detainees and guards with a minimum of 2 guards present at all times. The RHA NCOIC will ensure that guard force is assigned areas of work to include interior, exterior guard, and RTO.
- g. Interior guards will conduct check all cells with detainees constantly. At least once every 30 minutes checks will be recorded on cell logs. Guards coming onto shift will ensure the presence of all detainees and their compliance of established guidelines as brief to them upon their reception at RHA.
- h. Exterior guards will perform roving patrol outside the RHA structure. Securing access to the RHA facility, inspecting the perimeter integrity, and providing presence to discourage escape.
- i. Prior to shift change the outgoing Shift NCOIC will conduct a full inspection of the RHA area and conduct a prisoner count with the incoming Shift NCOIC present. Only after inspections are complete and detainees are accounted for will the outgoing NCOIC and Guards be relieved of duty.
- j. If a detainee is unaccounted, at any time guards, will IMMEDIATELY report the absence to the Shift NCOIC who will in turn notify Camp Muleskinner FPC at DNV: 587-5027.

Health and Welfare:

- a. Ensure that detainees maintain the cleanliness of their respective holding cell.
- b. The guard force is responsible for the cleanliness of the common areas and police call around the RHA. Police call and trash removal will be conducted at the change of shifts.
- c. Daily inspections of cells will be conducted to ensure integrity, security, and cleanliness of the cells. Any attempts to weaken the cells will result in the detainee being restrained (zip-tied) and removed from the cell so that repairs / corrections can be made.

001075

- d. Ensure that the detainees are provided meals (MREs) and water throughout their shift. Meals will be given out at 0800, 1200, and 1800 hours daily. Empty water bottles will be filled and given to each detainee upon request. Guards will ensure there is enough potable water on hand to re-fill the bottles as needed.
- e. If any medical issue is identified, the shift NCOIC will notify the chain of command and proper medical treatment will be given. Medic support will be requested for the RHA IOT determine what level of treatment the EPW requires. If determined that the detainee has to be transferred to the medical treatment facility, RSS, Transportation will be provided with guards to RSS. The medic will stay with the patient as needed to brief the on call PA of symptoms found.
- f. If adequate supplies are available, detainees will be permitted to conduct personal hygiene in the morning under the supervision of the RHA guards.

Guard Procedures and Policies:

- a. Maintain an "Amber" weapon status with magazine in well and the selector switch on safe. Upon shift change, the off going guards will move to the nearest clearing barrel and clear their weapon. Guards will maintain positive control of their weapons while on duty. At no time will the weapon be left unattended or under the control of another guard.
- b. Maintain and enforce the uniform policy. The uniform for inside the RHA is DCUs, but may be upgraded as the situation dictates. At no time will the guards remove their blouse while on duty.
- c. Guards will be permitted to leave the RHA to use the latrine, however, they are not permitted to go to the barracks/ sleeping areas to wake up the next shift or to return for anything personal.
- d. While not on stand-by, (i.e. on interior /exterior guard duty) guards will NOT eat, drink soft drinks, read, write letters, or conduct any other business that may distract them while on duty. Guards are not permitted to leave the RHA without ensuring that the detainee guard ration is maintained.
- e. Personal property / evidence will be inventoried, tagged, and stored by the RHA NCOIC upon receipt of detainee at the RHA. All weapons shall be transferred to the RSS weapons milvan for storage.

3. Point of contact for this policy memorandum is



Exemptions 3+6 Names withheld  
Normally would not release discussion  
of training requirements however

[REDACTED]

From: [REDACTED] COL [REDACTED]@us.army.mil  
Sent: Wednesday, May 12, 2004 5:51 PM  
To: [REDACTED] LTC G3  
Cc: [REDACTED] MR; [REDACTED] LTC; [REDACTED] MSG; [REDACTED] COL  
Subject: RE: Training for Treatment of Prisoners

Follow Up Flag: Follow up  
Flag Status: Flagged



31E TSP List.ppt

[REDACTED]

Here is the initial task list we will use in developing the TSP. We probably will add additional tasks but this should give you an idea from where will start. [REDACTED]

[REDACTED]

COL, MP  
Director of Training  
United States Army Military Police School  
Ft Leonard Wood, MO 65473  
Comm: (573) 563 [REDACTED]  
DSN: 676- [REDACTED]  
[REDACTED]wood.army.mil

-----Original Message-----

From: [REDACTED] COL - G3-TR [mailto:[REDACTED]@us.army.mil]  
Sent: Wednesday, May 12, 2004 9:08 AM  
To: [REDACTED] COL; [REDACTED] COL - G3-TR  
Cc: [REDACTED] LTC - G3; [REDACTED] - LTC G3; [REDACTED]  
- LTC G3; [REDACTED] SGM; [REDACTED] LTC  
Subject: RE: Training for Treatment of Prisoners

Thanks ... LTCs [REDACTED] cc'd here, are working this action.

[REDACTED]

-----Original Message-----

From: [REDACTED] COL [mailto:george.j.millan@us.army.mil]  
Sent: Wednesday, May 12, 2004 9:20 AM  
To: [REDACTED] COL - G3-TR; [REDACTED] COL  
Cc: [REDACTED] LTC - G3; [REDACTED] - LTC G3; [REDACTED] LTC G3; [REDACTED]  
SGM (E-mail); [REDACTED] LTC (E-mail)  
Subject: RE: Training for Treatment of Prisoners

[REDACTED] I'm out all day in an EEO inquiry but will give this to one of my guys to work today. Will get back to you soonest. [REDACTED]

[REDACTED]

COL, MP  
Director of Training  
United States Army Military Police School  
Ft Leonard Wood, MO 65473  
Comm: (573) 563- [REDACTED]

1031  
FORS COM #64

DSN: 676-

wood.army.mil

-----Original Message-----

From: [REDACTED] COL - G3-TR [mailto:[REDACTED]@us.army.mil]

Sent: Wednesday, May 12, 2004 5:10 AM

To: [REDACTED] COL

Cc: [REDACTED] LTC - G3; [REDACTED] - LTC G3; [REDACTED]

- LTC G3

Subject: RE: Training for Treatment of Prisoners

[REDACTED]

Want to publish guidance for specific pre deployment training required for units going over to perform detainee mission ... Previous guidance has stated all units must be proficient in METL derived for mission ... But didn't address each type unit.

Talked w/ MG Barrett yesterday ... He says you all have recommended tasks ... Would appreciate your help here

Also, looking at what training should be required of all soldiers prior to deployment ... Already require Law of Land Warfare and handling of POWs ... Any other tasks you'd recommend?

Thanks,

-----Original Message-----

From: [REDACTED] COL [mailto:[REDACTED]@us.army.mil]

Sent: Tuesday, May 11, 2004 6:19 PM

To: [REDACTED]@us.army.mil'

Subject: Training for Treatment of Prisoners

[REDACTED]

Received instructions from BG Curry to call you ref above. Give me a call or email./[REDACTED]

[REDACTED]

COL, MP

Director of Training

United States Army Military Police School

Ft Leonard Wood, MO 65473

Comm: (573) 563-[REDACTED]

DSN: 676-[REDACTED]

[REDACTED]@wood.army.mil

**31E Training Support Package Task List**

1. Introduction to Detainee Operations (OIF Detainee Definitions)
2. Communicate with Detainees (Muslim Cultural Awareness)
3. Geneva Conventions (Humane Treatment of Detainees)
4. Stress Management
5. HIV/Universal Precautions within Detainee Operations
6. Use of Force for Detainee and Interrogation Operations DROE/IROE)
7. Detainee Frisk, Undress, Cell and Area Search Procedures
8. Restraint Procedures for Detainees
9. Personal Safety Awareness
10. React to a Physical Attack using Unarmed Self Defense Techniques
11. Forced Cell Move (FCM) Procedures
12. Respond to a Bomb Threat and/or a Bomb within Detainee Operations
13. Emergency Actions for Fire, Escapes and Disorders within Detainee Facilities
14. Cell Block Operations within a Detainee Camp
15. Accountability Procedures
16. Perform Security and Control Activities within Detainee Operations
17. Special Housing Unit (SHU) / Segregation Operations
18. Main Gate/Sally Port Operations
19. Visitation Procedures
20. Escort Procedures within Detainee Operations
21. Meal Operations within a Detainee Camp
22. Non-Lethal Weapons Capabilities during Disorders/Disturbances within Detainee Operations

Exemption 3 He - names withheld

[REDACTED]

---

**From:** [REDACTED] - LTC G3  
**Sent:** Tuesday, August 24, 2004 5:16 PM  
**To:** [REDACTED] / CPT - G3 AXO  
**Cc:** [REDACTED] - LTC G3; [REDACTED] LTC - G3  
**Subject:** Detainee Ops 24 Aug



Detainee Ops 24  
Aug.doc

Made the corrections .. thanks